



U.S. ARMY RESERVE
NETWORK ENTERPRISE CENTER
INFRASTRUCTURE TECHNICAL CRITERIA

July 7, 2016

FOREWORD

This criteria is a living document and will be periodically reviewed and updated. As part of the Army Reserve's responsibilities to provide technical criteria for infrastructure design and construction, this document and all updates will be made available to all users. The proponent for Army Reserve Information Technology is USARC G-6. Development and maintenance of this criteria is the responsibility of USARC G-6, in coordination with ARIM-D, USACE, and ISEC.

AUTHORIZED BY:

Leo I. McGee
Lieutenant Colonel, GS
Chief, Networking and Infrastructure Branch, G-6

Table of Contents

1. Chapter 1 – Introduction and General Overview.....	4
1.1. Purpose and Applicability of this Document.....	4
1.2. Strategy for Delivery of Telecommunication Services for Army Reserve Facilities	4
1.3. Information and Communications Technology Service and Distribution Spaces	4
1.4. Telecommunications Qualifications	6
2. Chapter 2 – Infrastructure Requirements.....	7
2.1. Pathways.....	7
2.1.3. Outside Plant (OSP) Pathways	7
2.1.4. Inside Plant (ISP) Pathways	7
2.1.5. Cabling Support.....	8
2.2. ICT Racks and Cabinets	9
2.3. Backbone cabling	10
2.4. Horizontal cabling	10
2.4.6. Cable Jacket and ICT Jack Colors	11
2.4.7. Wireless ICT Outlets	11
2.4.8. Admin. Common Spaces ICT Outlets	12
2.4.9. Terminations.....	12
2.4.10. Horizontal Cabling Slack.....	12
2.5. Labeling.....	12
2.6. Testing	12
2.7. SIPRNet.....	13
2.8. Intrusion Detection System (IDS)	13
2.9. HVAC.....	13
2.10. Electrical.....	13
2.11. Grounding and Bonding	14
Appendix A – Glossary of Terms and Acronyms	16
Appendix B - Infrastructure Technical Criteria Diagrams and Details	17

1. Chapter 1 – Introduction and General Overview

1.1. Purpose and Applicability of this Document

- 1.1.1. The purpose of this document is to define Army Reserve standards and requirements for information and communication technology (ICT) infrastructure, specifically standards and requirements for new sites and existing facilities as well as site and facility modernization. This document defines the requirements needed to ensure consistent and compliant design and construction of ICT infrastructure throughout the Army Reserve.
- 1.1.2. Army Reserve telecommunications strategy will evolve over time and individual facilities may have unique requirements. The USARC G-6 Network Enterprise Center (NEC) reserves the right to issue Infrastructure Criteria Update Bulletins as needed. These bulletins will be used to supplement this document. The USARC G-6 Network Enterprise Center (NEC) has the responsibility for authorizing individual criteria updates, as well as additions to or variations from the criteria contained in this document.
- 1.1.3. The USARC G-6 NEC is the proponent for all ICT infrastructure requirements and shall participate in individual project scope review, pre-design, charrette, and design meetings to review and define the infrastructure requirements for these projects. USARC G-6 NEC is also the proponent for quality control (QC) inspections for all initiatives, projects, efforts, etc. involving ICT infrastructure.
- 1.1.4. This criteria and the Army Installation Information Infrastructure (I3A) criteria are required documents and must be included and complied with in the design and specifications for all projects.
 - 1.1.4.1. For clarification on relationship between the I3A and this criteria the following is to be adhered to:
 - 1.1.4.1.1. The I3A criteria is the governing document for infrastructure design and construction.
 - 1.1.4.1.2. This criteria supplements the I3A with requirements unique to the Army Reserve.
 - 1.1.4.1.3. The USARC G-6 NEC Infrastructure Team Lead will address any conflicts between the I3A and this document.
 - 1.1.4.1.4. Refer to I3A for all requirements not specifically addressed in this criteria.
- 1.1.5. This document does not supersede any contract for design or construction of any individual Army Reserve project; if conflicts exist between this document and a contract, the conflict must be brought to the attention of the appropriate project manager for resolution.

1.2. Strategy for Delivery of Telecommunication Services for Army Reserve Facilities

- 1.2.1. When a Reserve Center is located off of an installation, camp, post, or station (e.g. Standalone USARC), the Army Reserve Command G-6 will provision both voice and data services.
- 1.2.2. When a Reserve Center is located on an installation, camp, post, or station, the Army Reserve Command G-6 will provision data services to be delivered to the installation demarcation point. The service will then be extended thru the installation distribution backbone.
- 1.2.3. When a Reserve Center is located on an installation, camp, post, or station, the Army Reserve prefers to obtain voice services from the installation. If the installation cannot provide voice services, USARC G-6 will provide direction on the way ahead with such services.

1.3. Information and Communications Technology Service and Distribution Spaces

- 1.3.1. Army Reserve ICT spaces are dedicated to housing voice and ARNet data services infrastructure and equipment.
- 1.3.2. Descriptions and requirements for Army Reserve ICT spaces are found in UFC 4-171-05 *Army Reserve Facilities Design Guide*. The information for ICT spaces listed in this document are in addition to what is specified in UFC 4-171-05.
- 1.3.3. Each site or campus shall have only one Entrance Facility (EF) (a.k.a. DEMARC).

- 1.3.3.1. The EF is typically located in the main training building. However, the EF location can vary depending on the needs of the site or campus.
- 1.3.3.2. When a Reserve Center is located on a military installation, camp, post, or station, the site DEMARC shall be determined by the installation host (e.g. Active Army NEC).
- 1.3.3.3. The voice and data services from the public service provider shall terminate in the EF and be extended from the EF to the Telecommunications Equipment Room (TER).
- 1.3.4. Unless a joint use site, each Army Reserve site or campus shall have only one TER.
 - 1.3.4.1. The TER is typically located in the main training building. However, the TER location can vary depending on the needs of the site or campus.
 - 1.3.4.2. If joint use site, provide a TER for each Service (e.g. Army Reserve, Army National Guard, USMC, etc.) occupying the site.
 - 1.3.4.3. Additional Telecommunications Rooms (TRs) are required for every 10,000 sq. ft. of usable floor space. Note that additional TRs may be required in larger buildings to maintain compliance with TIA/EIA 295 ft. (90 m.) horizontal link distance limit. Provide a TR for each Service (e.g. Army Reserve, Army National Guard, USMC, etc.) occupying a joint-use Reserve Center (AFRC). A TR is not required in buildings with minimal or no telecommunications requirements (e.g. Unheated Storage Building). When calculating the number of TRs required, note that the TER counts as a TR. The following spaces are typically not considered as useable floor space and do NOT need to be considered in the calculation of usable floor space:
 - 1.3.4.3.1. Hallways/Corridors
 - 1.3.4.3.2. Vestibules
 - 1.3.4.3.3. Lobbies
 - 1.3.4.3.4. Storage Rooms
 - 1.3.4.3.5. Kitchens (Except the Kitchen Office)
 - 1.3.4.3.6. Scullery
 - 1.3.4.3.7. Mechanical Rooms
 - 1.3.4.3.8. Electrical Rooms
 - 1.3.4.3.9. Janitors Closets
 - 1.3.4.3.10. Physical Readiness
 - 1.3.4.3.11. Locker Rooms
 - 1.3.4.3.12. Restrooms
 - 1.3.4.3.13. Unit Storage
 - 1.3.4.3.14. Arms Vault
 - 1.3.4.3.15. Elevator
 - 1.3.4.3.16. Elevator Machine Rooms
 - 1.3.4.3.17. Stairwells
 - 1.3.4.3.18. Battery Room
 - 1.3.4.3.19. Fluid Distribution
 - 1.3.4.3.20. Controlled Waste
 - 1.3.4.3.21. Vending Areas
- 1.3.5. There shall not be any equipment (piping, ductwork, machinery, etc.) that does not serve the EF, TER, TR installed above, below (e.g. in or below slab) or in the EF, TER, TR nor will this equipment pass-through or enter the EF, TER, TR spaces. Add the following note to the applicable Fire Safety, Plumbing, and Mechanical design sheets, design analysis, and specifications:
“Equipment (piping, ductwork, machinery, etc.) that does not serve the EF, TER, or TR(s) shall not be installed above, below (e.g. in or under slab) or in these ICT spaces nor will this equipment pass through or enter the EF, TER, or TR(s).”

- 1.3.6. All motors, transformers, or other electrical devices greater than 5KVA are required to have a minimum of a 47” buffer from any wall of the EF, TER, TR(s) and ICT Cabinet locations. Add the following note to the applicable Electrical and Mechanical design sheets, design analysis, and specifications: “Any motor, transformer, or other electrical device greater than 5KVA will have a minimum of a 47” buffer from any wall of the EF, TER, or TR(s).”
- 1.3.7. Cabling and equipment not directly needed in support of ARNet data and voice services shall not be terminated in, pass-thru, or be located in the TER, TR(s), or TE(s). This includes cabling and equipment for physical access control systems (PACS) and cable television (CATV) systems. CATV head-end equipment and cabling shall be terminated in the EF.
- 1.3.8. Windows are not allowed on any wall or door, of the EF, TER, or TR(s).
- 1.3.9. The minimum square footage requirements for ICT spaces as listed in UFC 4-171-05 have been superseded by the following:
 - 1.3.9.1. EF = 48 square feet (typical 6’ x 8’)
 - 1.3.9.2. TER = 80 square feet (typical 8’ x 10’)
 - 1.3.9.3. Standard TR = 80 square feet (typical 8’ x 10’)
 - 1.3.9.4. Small TR = 48 square feet (typical 6’ x 8’) – Note that the use of a small Telecommunications Room shall be limited to areas that serve 144 or fewer horizontal cabling terminations.
- 1.3.10. If a joint use facility, shared spaces (e.g. classrooms, assembly hall), will require separate ICT outlets for each DOD component (e.g. Army Reserve, Army National Guard). The ICT DOR can place the separate outlets in the same faceplate where appropriate.

1.4. Telecommunications Qualifications

- 1.4.1. The certified final design submittal is to be reviewed and approved by an active Building Industry Consulting Services International (BICSI) Registered Communications Distribution Designer (RCDD) and indicated as such with the RCDD’s stamp and signature on the design submittal cover page.
- 1.4.2. The on-site foreman assigned to the installation of this system or any of its components shall be an active Building Industry Consulting Services International (BICSI) Registered Cabling Installer, Technician Level with a minimum of 5 years’ experience in the installation of low-voltage cabling systems. All other personnel assigned to the installation of this system must have a minimum of 3 years’ experience in the installation of low-voltage cabling systems or any of its components. It is preferred that these personnel have a minimum of an active Building Industry Consulting Services International (BICSI) Registered Cabling Installer, Level 1. Documentation of current BICSI certification for each of the key personnel must be provided.

2. Chapter 2 – Infrastructure Requirements

2.1. Pathways

- 2.1.1. Provide a complete telecommunications pathway system that provides a flexible, re-usable, expandable pathway for premises and outside plant distribution of telecommunication services throughout the facility.
- 2.1.2. The preferred pathway for installing service entrance and campus outside plant (OSP) cables is underground duct bank. Aerial pathways will only be considered where the use of underground pathways is not a viable option. The use of aerial pathways must be explicitly approved by USARC G-6 prior to design and/or implementation.
- 2.1.3. Outside Plant (OSP) Pathways
 - 2.1.3.1. On an installation, camp, post, or station, the OSP pathways criteria will be determined by the installation.
 - 2.1.3.2. Service Provider Point of Connection (SPPOC)
 - 2.1.3.2.1. Provide two 4-inch-conduits from the Entrance Facility (EF) to the Local Exchange Carrier (LEC) point of connection.
 - 2.1.3.2.2. Provide one 4-inch conduit from the Entrance Facility (EF) to the Cable Television (CATV) point of connection.
 - 2.1.3.2.3. Designer of Record shall coordinate with the LEC and CATV provider to determine the point of connection location(s) and conduit termination requirements (e.g. maintenance hole, hand hole, pedestal, telephone pole).
 - 2.1.3.3. For all buildings where ARNET and voice services are needed, provide two 4-inch conduits from the TER to other buildings TR or Telecommunications Enclosure (TE).
 - 2.1.3.3.1. Provide one 3 inch-3 cell fabric mesh inner-ducts with tracer wire in one of the two conduits.
 - 2.1.3.4. For all buildings where only voice services are needed, provide one 4-inch conduit from the TER to other buildings TR or TE.
 - 2.1.3.4.1. Provide one 3 inch-3 cell fabric mesh inner-duct with tracer wire in this conduit.
- 2.1.4. Inside Plant (ISP) Pathways
 - 2.1.4.1. Provide one 4-inch conduit from the EF to the TER. If the cable tray system extends to the corridor immediately outside the EF and TER, then this conduit may be omitted and backbone cable may be routed thru cable tray.
 - 2.1.4.2. Provide one 4-inch conduit from the TER to each TR. If the cable tray system extends to the corridor immediately outside the TER and TR, then this conduit may be omitted and backbone cable may be routed thru cable tray.
 - 2.1.4.3. Floor and Wall Penetrations
 - 2.1.4.3.1. The initial fill capacity of each floor penetration or wall sleeve shall be 80 percent or less. One spare, empty penetration or sleeve shall also be provided.
 - 2.1.4.3.2. All wall penetrations in fire-rated walls shall require the use of self-sealing, re-entenable, mechanical fire-stop assemblies.
 - 2.1.4.3.2.1. If unable to determine fire-rating of the wall, then the use of self-sealing, re-entenable, mechanical fire-stop assemblies is required.
 - 2.1.4.3.3. All multi-story floor penetrations shall require the use of self-sealing, re-entenable, mechanical fire-stop assemblies.
 - 2.1.4.3.4. Fire stopping plugs shall be used on all 2 and 4 inch sleeves and conduits requiring fire-stopping.

2.1.4.4. Horizontal cabling conduit requirements

- 2.1.4.4.1. All conduits must be sized for an initial fill ratio of 40% or less. This 40% fill ratio must be based on a horizontal cabling outside diameter of .22 inches. The minimum size conduit allowed to be used is one inch.
- 2.1.4.4.2. Modular furniture system connections (up to 12 Category 6 cables) require a 1.5 inch liquid-tight flexible metal conduit and fittings to connect each floor box or wall box to the acoustic panel raceway.
- 2.1.4.4.3. All in-slab floor box locations require two 1 inch (minimum) conduits. Only the first conduit can have cable installed. The-second conduit shall have a pull string installed but be otherwise un-used.

2.1.5. Cabling Support

- 2.1.5.1. Where feasible and cost effective, all low-voltage signal cable from all low-voltage systems can share the same corridor pathway (e.g. cable tray, conduit). For all projects located on installations, camps, posts, and stations, NEC approval is required before using this approach.
- 2.1.5.2. Cable tray
 - 2.1.5.2.1. Cable tray usage is for pathways and horizontal distribution outside of the ICT spaces. Cable tray cannot enter the EF, TER, or any TR.
 - 2.1.5.2.2. The cable tray system shall originate in the corridor outside of the TER and TR and shall serve the respective area served by that TER or TR. It shall support a minimum of 90% of the premise cabling.
 - 2.1.5.2.3. Distance from conduit stub out to cable tray shall not exceed 40 feet.
 - 2.1.5.2.4. Cable tray is not allowed in hard ceiling areas. Refer to I3A for cabling installation in hard ceilings.
 - 2.1.5.2.5. Cable tray shall be sized so the sum of the cross-sectional areas of the low-voltage cabling will not exceed 40 percent of the interior cross-section of the cable tray
 - 2.1.5.2.6. The minimum size cable tray allowed is 6 inches wide x 2 inches deep.
 - 2.1.5.2.7. The maximum depth cable tray allowed is 6 inches
 - 2.1.5.2.8. Provide 12-inch minimum clearance above the top of the cable tray and 3-inch minimum clearance below the cable tray
 - 2.1.5.2.9. The use of center hung and cantilever mounting systems for cable tray is not allowed.
- 2.1.5.3. Non-continuous cable support
 - 2.1.5.3.1. J-hooks are the only approved non-continuous cable support method. They shall not replace cable tray, but can be used to provide cable support where the use of cable tray is not feasible.
 - 2.1.5.3.2. J-hooks shall be Category 6 rated and spaced at intervals that shall not exceed 60 inches from the conduit stub up or ceiling entry point to the cable tray.
 - 2.1.5.3.3. Each J-hook shall not exceed 50 percent of the J-hook fill capacity.
 - 2.1.5.3.4. J-Hooks shall not be installed over, above, or through hard ceiling areas.
- 2.1.5.4. ICT spaces
 - 2.1.5.4.1. Ladder rack is the only approved cabling support method allowed in the EF, TER and all TRs. Both horizontal and vertical style ladder rack shall be used. Basket style cable tray shall not enter or pass through the EF, TER, or any TR.
 - 2.1.5.4.2. Ladder rack shall be 1-1/2 inch x 3/8 inch stringers with 1/2 inch x 1 inch welded rungs at 12-inch intervals.
 - 2.1.5.4.3. The minimum width for all horizontal ladder rack is 18 inches.
 - 2.1.5.4.4. The minimum width for all vertical ladder rack is 12 inches.

- 2.1.5.4.5. Ladder rack shall be secured to the wall and/or ceiling deck above. Use only wall mount or trapeze mounting systems.
- 2.1.5.4.6. Ladder rack above equipment racks shall be fastened to these racks with 6 inch elevation kits and rack to runway mounting kits.
- 2.1.5.4.7. Radius dropouts (waterfalls) shall be used in all locations where the premise cabling is routed to the equipment rack below. All radius dropouts for the ICT racks shall be attached to the ladder rack and shall be the same width as the ladder rack used.
- 2.1.5.4.8. Use radius dropouts in all locations where the premise cabling is routed from the wall fire-stop sleeve to the ladder rack below.
- 2.1.5.4.9. If the distance from the exit point of the conduit/sleeve to the ladder rack below exceeds 5 foot, then the cable must be supported from the exit point of the conduit/sleeve until it meets the ladder rack
- 2.1.5.4.10. Horizontal category 6 cabling shall be properly supported on the back of the patch panel. Support brackets shall be compatible with the Category 6 patch panels installed.
- 2.1.5.4.11. The use of plastic tie-wraps on all horizontal category 6 cabling is NOT allowed. $\frac{3}{4}$ inch (minimum) size Velcro fasteners must be used.
- 2.1.5.4.12. Provide vertical and horizontal cable managers in the quantities as shown in Appendix B: Infrastructure Technical Criteria Diagrams and Details. Vertical cable managers shall be:
 - 2.1.5.4.12.1. Minimum 6 inches wide
 - 2.1.5.4.12.2. Double sided
 - 2.1.5.4.12.3. Double hinged
 - 2.1.5.4.12.4. Match the height of the rack
 - 2.1.5.4.12.5. Bolted to ICT racks (to both racks if placed in between two racks)

2.2. ICT Racks and Cabinets

- 2.2.1.1. Provide two post, heavy-duty racks in quantities sufficient to accommodate the cabling systems and equipment for the project. At a minimum, provide the quantities as shown in Appendix B: Infrastructure Technical Criteria Diagrams and Details. Racks shall be:
 - 2.2.1.1.1. EIA-310-D compliant
 - 2.2.1.1.2. Supports 19 inch wide EIA rack mount equipment
 - 2.2.1.1.3. Equipment static load capacity of 1500 lbs.
 - 2.2.1.1.4. 45 U (7 feet) height
 - 2.2.1.1.5. EIA-310-D compliant, Universal hole pattern
 - 2.2.1.1.6. $\frac{5}{8}$ "- $\frac{5}{8}$ "- $\frac{1}{2}$ " vertical hole spacing
 - 2.2.1.1.7. Threaded #12-24 equipment mounting holes with included equipment-mounting screws
 - 2.2.1.1.8. Fixed in place
 - 2.2.1.1.9. Pre-marked and numbered rack-mount spaces
 - 2.2.1.1.10. Integrated grounding with a built-in attachment point for a ground (Earthing) connection
- 2.2.1.2. If floor mounted lockable ICT cabinets are used in place of ICT racks they shall meet the minimum specifications for ICT racks and are to be 36" in depth and have adequate internal ventilation (louvers and fan kit). Fan kit shall be mounted to the interior, top of the cabinet. Multiple ICT cabinets used on the same site must all be keyed alike.
- 2.2.1.3. The use of wall mounted ICT cabinets will only be allowed with USARC G-6 approval. If allowed, cabinets shall be:
 - 2.2.1.4. Width of: 24 inches; 19 inches EIA rack-mount
 - 2.2.1.5. Heights: 24 inches for port densities of 48 ports or less, 48 inches for port densities of 49

ports or more

- 2.2.1.6. Depth: 36 inches
- 2.2.1.7. Lockable front door with swing-out rear access to equipment
- 2.2.1.8. Usable interior space:
 - 2.2.1.8.1. 12 Rack Management Unit (RMU) (24 inch cabinet)
 - 2.2.1.8.2. 26 RMU (48 inch cabinet)
 - 2.2.1.8.3. 1 pair L-shaped equipment mounting rails in the main cabinet body (adjustable depth)
 - 2.2.1.8.4. 19"W, EIA-310-D compliant rails
 - 2.2.1.8.5. Universal hole pattern, 5/8"-5/8"-1/2" vertical hole spacing
 - 2.2.1.8.6. Threaded #12-24 equipment mounting holes with included equipment-mounting screws
 - 2.2.1.8.7. Re-marked and numbered rack-mount spaces
 - 2.2.1.8.8. Integrated grounding with a built-in attachment point for a ground (Earthing) connection
 - 2.2.1.8.9. Load capacity: minimum 200 pounds (90.7 kg) of equipment, open or closed
 - 2.2.1.8.10. Vented, with louvers and fan kit included. Fan kit shall be mounted to the interior, top of the cabinet.
 - 2.2.1.8.11. Multiple ICT cabinets used on the same site must all be keyed alike. If a joint use facility, different keys must be used for each component.
 - 2.2.1.8.12. The cabinet shall be configured and mounted such that the hinged side of the cabinet is adjacent to the conduits feeding the cabinet.

2.3. Backbone cabling

- 2.3.1. All backbone fiber optic cabling shall be single-mode OS2 rated as defined in TIA 492CAAB.
- 2.3.2. All backbone copper cabling shall be category 5 rated.
- 2.3.3. Cabling for the DS3 ARNET circuit extension shall be Siamese coaxial cable with RG59 BNC connectors. Cables shall be long enough so there is enough slack to reach the bottom of Rack 1 in the TER and have 20 ft. of slack in the EF.
 - 2.3.3.1. If the length of the coaxial cable will not exceed 250 feet, then a Siamese 735a coaxial cable is required.
 - 2.3.3.2. If the length of the coaxial cable will exceed 250 feet, then a Siamese 734 coaxial cable is required.
- 2.3.4. Cabling for the Ethernet ARNET circuit, POTs lines, and Voice PRI shall be category 6 cables. Terminate these cables on a RJ45 Category 6 patch panel.
 - 2.3.4.1. In the EF, a wall mounted patch panel is required. Locate this patch panel near the SPPOC conduits
 - 2.3.4.2. In the TER, a rack mounted patch panel is required. Locate this patch panel in rack 1.
- 2.3.5. Refer to Appendix B: Infrastructure Technical Criteria Diagrams and Details for minimum strand and pair counts and further details.

2.4. Horizontal cabling

- 2.4.1. Refer to Appendix B: Infrastructure Technical Criteria Diagrams and Details for the type ICT outlets and jacks required for each type of ICT outlet.
- 2.4.2. The use of multi-user telecommunications outlet assembly (MUTOA) is not allowed without explicit approval from USARC G-6.
- 2.4.3. For standard, flush wall-mounted ICT outlets, the use of low-voltage mounting brackets (e.g., mud ring, plaster ring, square-drawn cover, and box eliminator) is an approved alternative to the use of standard outlet boxes with stub-up conduit (non-fire rated walls only).
- 2.4.4. All cabling installed in conduit in or below a concrete slab that is in direct contact with the earth must be rated for use in wet locations.

- 2.4.5. Consolidation points for transition from wet-rated to plenum-rated cable must be used if the distance from the conduit exit point to the TER/TR exceeds 49 ft. or the cable will pass thru a plenum space. All consolidation points installed must allow for cabling from the wall outlet to the TER or TR to pass all Category 6 permanent link tests as tested from the wall outlet thru the consolidation point to the patch panel port.
- 2.4.6. Cable Jacket and ICT Jack Colors
- 2.4.6.1. When a Reserve Center is located off of an installation, camp, post, or station (e.g. Standalone USARC), the cable jacket and ICT jack color shall be blue.
- 2.4.6.2. When a Reserve Center is located on a military installation, camp, post, or station, the cable jacket and ICT jack color shall be determined by the installation host (e.g. Active Army NEC).
- 2.4.6.3. If the facility is joint-use, the cable jacket and ICT jack color will be determined by USARC G-6 during the design process.
- 2.4.7. Wireless ICT Outlets
- 2.4.7.1. Provide one Wireless Intrusion Detection (WID) outlet (2 jacks) for each facility.
- 2.4.7.1.1. This outlet shall be located in the accessible ceiling as closely as possible to the facility main entry door. The Unheated Storage (UHS) facility is excluded from this requirement.
- 2.4.7.2. For each facility, provide one Wireless Access Point (WAP) outlet (2 jacks) for each 40 by 40-foot square grid of the facility. The Unheated Storage (UHS) facility is excluded from this requirement.
- 2.4.7.2.1. WAP Outlet locations
- 2.4.7.2.1.1. In accessible (e.g. drop) standard height ceilings, the outlet shall be located as closely as possible to the center of each grid.
- 2.4.7.2.1.2. In non-accessible (e.g. hard) and high height (e.g. Assembly Hall, Workbay) ceilings, the outlet will be located on the wall located closest to the center of the grid.
- 2.4.7.2.1.3. The following spaces are excluded from the WAP outlet requirement. WAP outlets are not required in these spaces:
- 2.4.7.2.1.3.1. SIPRNet Room
- 2.4.7.2.1.3.2. Kitchen (except for Kitchen office)
- 2.4.7.2.1.3.3. Scullery
- 2.4.7.2.1.3.4. Mechanical Rooms
- 2.4.7.2.1.3.5. Electrical Rooms
- 2.4.7.2.1.3.6. Locker Rooms
- 2.4.7.2.1.3.7. Janitors Closets
- 2.4.7.2.1.3.8. Individual Storage Rooms
- 2.4.7.2.1.3.9. Restrooms
- 2.4.7.2.1.3.10. Arms Vault
- 2.4.7.2.1.3.11. Elevator
- 2.4.7.2.1.3.12. Elevator Machine Room
- 2.4.7.2.1.3.13. Stairwells
- 2.4.7.2.1.3.14. Battery Room
- 2.4.7.2.1.3.15. Fluid Distribution Room
- 2.4.7.2.1.4. WAP/WID Outlet Mounting Details
- 2.4.7.2.1.4.1. For all standard height (9 ft. or lower) accessible ceiling locations, each outlet will be mounted 12 inches above finished ceiling. **ALL OUTLETS INSTALLED ABOVE FINISHED CEILING MUST BE PERMANENTLY FIXED TO BUILDING STRUCTURE.**

2.4.7.2.1.4.2. For all standard height (9 ft. or lower) non-accessible ceiling locations, each outlet will be mounted at 8 feet AFF.

2.4.7.2.1.4.3. For high height (9 ft. 1 inch or higher) ceiling locations (e.g. Assembly Halls and Work Bays), each outlet will be mounted on the wall at 12 feet AFF.

2.4.8. Admin. Common Spaces ICT Outlets

2.4.8.1. 1 convenience ICT outlet (1 jack) is required for each table intended for TPU use. This outlet shall be located on a wall in the vicinity of the benching table.

2.4.8.2. 1 ICT outlet (1 jack) per workstation location is required for each desk intended for FTS use. This outlet shall be located directly adjacent to or under the desk.

2.4.9. Terminations

2.4.9.1. All horizontal cabling shall be terminated using T568B pin-out configuration.

2.4.9.2. The jack used shall be of the same color as the horizontal cabling jacket.

2.4.9.3. Standard wall phone outlets shall consist of a single-gang box with a single-gang, lug-type faceplate suitable for direct wall mounting of a telephone instrument.

2.4.10. Horizontal Cabling Slack

2.4.10.1. 10 feet of cable slack is required for each cable. This slack is to be stored in tear drop fashion on the ladder rack above the ICT rack(s) or cabinet(s).

2.4.10.2. 3 feet of horizontal cable slack is required for each ICT outlet location. Cable slack is to be stored within the cable tray or J-Hook closest to the ICT outlet in a tear drop fashion.

2.4.10.3. Service loops are not allowed at any time.

2.5. Labeling

2.5.1. All labeling shall be IAW the requirements as listed in ANSI/TIA 606 (Class 3 requirements) and the requirements in Appendix B: Infrastructure Technical Criteria Diagrams and Details.

2.5.2. Hand written labels are not acceptable.

2.5.3. All conduit labels must be self-laminating cable tags that are properly secured to the conduit. Self-laminating cable tags shall be installed on all backbone cabling immediately upon the exit of the floor/wall/or ceiling penetration and as close as practicable at the termination point.

2.5.4. If the facility is joint-use, then each ICT outlet shall be labeled with the branch of service as well (e.g. R for Army Reserve, G for Army National Guard). The exact additional labeling details will be determined by USARC G-6 during the design process.

2.6. Testing

2.6.1. All testing shall be performed IAW the requirements as listed in I3A, ANSI/TIA-568 and this criteria.

2.6.2. All testing devices used must have been calibrated/recertified within one year of performing field testing. Proof of calibration/recertification is to be provided with the test plan and test results.

2.6.3. Prior to conducting any testing, the contractor shall submit a test plan to USARC G-6. This test plan shall indicate all test equipment, testing methodology, and plan of delivery of test results to USARC G-6. This test plan must be approved by USARC G-6 prior to conducting any testing. All test results shall be supplied to USARC G-6 in Adobe PDF format.

2.6.4. Final acceptance testing is required for:

2.6.4.1. Horizontal cabling

2.6.4.2. Backbone fiber

2.6.4.2.1. Note that, In addition to the testing requirements listed in I3A, each strand of terminated fiber shall also be tested at both ends with an optical time domain reflectometer (OTDR).

2.6.4.3. Backbone copper

2.6.4.4. Ground to Earth Resistance for each TMGB and TGB

2.6.4.5. USARC G-6 is the approving authority for all of the above test results.

2.7. SIPRNet

2.7.1. Encryption within the SIPRNET Room will occur in an Information Process Station (IPS) container. This container shall be provided by the Government and installed by the Contractor. The Contractor is responsible for providing and installing all other ICT infrastructure within the SIPRNET Room. The requirements for this infrastructure are:

2.7.1.1. Provide and install one standard ICT outlet with one CAT6 cable. Cable jacket color and jack color shall be blue. Mount this box at standard outlet height. The location of this outlet shall be immediately adjacent to the IPS container. Cable shall be installed in EMT conduit (1 inch minimum) to the nearest TR/TER and terminated on a category 6 patch panel.

2.7.1.2. If the site has a Dedicated SIPRNet Room, provide and install the following;

2.7.1.2.1. One standard ICT outlet with three CAT6 cables. Cable jacket color and jack color shall be blue. Mount this box at standard outlet height. The location of this outlet shall be immediately beneath the table used for the secure fax machine. Cables shall use standard horizontal cabling pathways to the nearest TR/TER and terminated on a category 6 patch panel.

2.7.1.2.2. One SIPRNet ICT outlet for each SIPRNet workstation location. These outlets shall terminate in the IPS container. Additional requirements are:

2.7.1.2.2.1. Red cable jacket and jacks must be used for all SIPRNet ICT outlets.

2.7.1.2.2.2. Center the SIPRNet ICT outlets on each SIPRNet Workstation.

2.7.1.2.2.3. Mount at 54 inches AFF in an approved lockable outlet box.

2.7.1.2.2.4. The cabling shall be installed in a USARC approved hardened PDS (e.g. Holocomm) system.

2.7.1.2.2.5. Hardened PDS design shall be reviewed and approved by an individual with an active design engineer certification issued by the PDS manufacturer.

2.7.1.2.2.6. Hardened PDS Installers shall have active PDS installer certifications issued by the PDS manufacturer

2.7.1.2.2.7. Hardened PDS installation shall be certified by an individual with an active quality assurance certification issued by the PDS manufacturer.

2.7.1.2.3. Refer to Appendix B: Infrastructure Technical Criteria Diagrams and Details for further details and requirements.

2.8. Intrusion Detection System (IDS)

2.8.1. For each IDS control panel, provide and install two category 6 cables from the IDS panel to the appropriate TER/TR. Install both cables in a single 1 inch EMT conduit. In the TER/TR, terminate these cables on the category 6 patch panels. In the IDS Panel, terminate these cables with an 8P8C jack. Provide 8-12 inches of slack cable in the IDS panel.

2.8.2. Refer to Appendix B: Infrastructure Technical Criteria Diagrams and Details for further details.

2.9. HVAC

2.9.1. The EF, TER and all TR(s) shall be properly conditioned to meet the control, availability, temperature, and humidity requirements as listed in UFC 4-171-05, I3A, and ANSI/TIA/EIA-569. Back-up systems are not required, but if an emergency power source is available in the facility, connect the HVAC system that serves each ICT space to the emergency power source.

2.10. Electrical

2.10.1. The electrical panel that serves the EF, TER, and each TR must be located in and dedicated to the space it serves. This panel must meet the following minimum requirements:

2.10.1.1. 120/208 volt, 3-phase, panel with a minimum 100 ampere total capacity.

2.10.1.2. All loads within the EF, TER, and each TR shall be fed from the dedicated panel and not from other branch circuits. No other loads shall be fed from this panel.

- 2.10.1.3. A minimum of 30 Amp spare capacity shall be reserved in each panel with a minimum of four unused spaces for future loads.
- 2.10.1.4. Back-up systems are not required, but if an emergency power source is available in the facility, connect the panel that serves the EF, TER, and each TR to the emergency power source.
- 2.10.2. Provide and install one (1) dedicated 120V/20 circuit with one (1) double duplex NEMA 5-20 receptacle for each ICT rack or cabinet in the TER, each TR, and each ICT cabinet.
 - 2.10.2.1. Mount the receptacle at 6-8 inches AFF on the side of the ICT rack.
 - 2.10.2.2. Mount the receptacle inside the ICT cabinet in the lower, left corner.
- 2.10.3. In the EF, provide and install the following:
 - 2.10.3.1. One (1) dedicated 120V/20 circuit with one (1) double duplex NEMA 5-15 receptacle.
 - 2.10.3.2. One (1) dedicated 120V/20 circuit with one (1) double duplex NEMA L5-15 receptacle.
 - 2.10.3.3. If provided specific power requirements by the local service provider, provide and install electrical receptacles that meet these requirements. Each of these receptacles shall be on a dedicated circuit.
 - 2.10.3.4. Mount all receptacles at 18 inches AFF on the plywood backboard immediately adjacent to the service provider conduits.
- 2.10.4. Provide and install one (1) dedicated 120V/20 circuit with one (1) double duplex NEMA 5-20 receptacle for the IPS container in the SIPRNet Room. Mount the receptacle immediately adjacent to the IPS container at standard outlet height.
- 2.10.5. Provide and install convenience receptacles in the EF, TER, and each TR IAW I3A requirements.
- 2.10.6. Refer to Appendix B: Infrastructure Technical Criteria Diagrams and Details for further details.
- 2.11. **Grounding and Bonding**
 - 2.11.1. The design for grounding and bonding shall meet or exceed all requirements of ANSI/TIA-607-B and NFPA 70 and shall include grounding and bonding for the following:
 - 2.11.1.1. EF, TER, each TR, each ICT rack, each ICT cabinet location, SIPRNet room (if dedicated).
 - 2.11.2. Telecommunications Main Grounding Busbar (TMGB)/Telecommunications Grounding Busbar (TGB) requirements are as follows:
 - 2.11.2.1. Mounting height in the EF, TER, each TR, and each ICT cabinet location shall be 6 feet 6 inches AFF.
 - 2.11.2.2. Mounting height for the TMGB/TGB in the dedicated SIPRNet Room shall be 18 inches AFF.
 - 2.11.2.3. Minimum of 24 inches in length.
 - 2.11.2.4. Predrilled with standard 5/16" Holes in a 2 hole configuration.
 - 2.11.2.5. Listed insulators and mounting brackets.
 - 2.11.2.6. A minimum of 50.8 mm separation from the wall is required to allow access to the rear of the bus bar.
 - 2.11.2.7. Electro-tin-Plated (ETP) and a copper or a copper alloy with a minimum of 95% conductivity.
 - 2.11.2.8. All bonding conductors shall be fastened to each TMGB/TGB with 2-hole compression type, long barrel connectors.
 - 2.11.2.9. Wherever feasible, all bonding conductors for each item bonded to a TMGB/TGB shall be 2-hole compression type, long barrel connectors.
 - 2.11.3. Rack grounding Busbar (RGB) requirements are as follows:
 - 2.11.3.1. Each ICT rack shall have an RGB.
 - 2.11.3.2. Locate the RGB at the top rear of the rack
 - 2.11.3.3. Each RGB shall be a copper or a copper alloy with a minimum of 95% conductivity.
 - 2.11.3.4. Each ICT Rack shall be bonded to its RGB with a minimum #6 AWG size bonding

conductor. This bonding connection shall not impede the installation of other rack-mounted equipment.

2.11.4. Prior to installing any bonding conductors, an anti-oxidant compound shall be applied to all grounding and bonding surfaces.

2.11.5. Refer to Appendix B: Infrastructure Technical Criteria Diagrams and Details for further details.

Appendix A – Glossary of Terms and Acronyms

1391 = MILCON Project authorization form
AFF = Above Finished Floor
ANSI = American National Standards Institute
AR = Army Reserve
ARNET = Army Reserve Network
AWG = American Wire Gauge
CATV = Community/Cable Access Television
EF = Entrance Facility
HDPE = High Density Polyethylene
HVAC = Heating, Ventilating and Air Conditioning
IDS = Intrusion Detection System
I3A = Technical Criteria for Installation Information Infrastructure Architecture
IPS= Information Processing Station
ICT = Information and Communications Technology
LEC= Local Exchange Carrier (a.k.a. Telephone Company)
NEC= Network Enterprise Center
NEMA = National Electrical Manufacturers Association
OSP = Outside Plant
OTDR = Optical Time Domain Reflectometer
PDS = Protected Distribution System
PVC = Polyvinyl Chloride
RMU= Rack Management Unit
SIPRNet = Secret Internet Protocol Router Network
SM = Single Mode
TER = Telecommunications Equipment Room
TGB = Telecommunications Grounding Busbar
TIA/EIA = Telecommunications Industry Association/Electronics Industries Alliance
TMGB = Telecommunications Main Grounding Busbar
TR = Telecommunications Room
UFC = Unified Facility Criteria
UHS = Unheated Storage
UPS = Uninterruptible Power Supply
USARC = U.S. Army Reserve Command
VOIP = Voice-Over-Internet-Protocol

Appendix B - Infrastructure Technical Criteria Diagrams and Details

The diagrams and figures provided in this appendix provide additional requirements and guidance. All Army Reserve infrastructure design and construction shall adhere to the requirements listed in these diagrams and details.



U.S. ARMY RESERVE NETWORK ENTERPRISE CENTER INFRASTRUCTURE TECHNICAL CRITERIA DIAGRAMS AND DETAILS



SYMBOL	REVISIONS	
	DESCRIPTION	DATE / APPR.

DESIGNED BY: JOHN BABB	DATE: JUNE 2016
DESIGNED BY: DEREK MITCHELL	FOR OFFICIAL USE ONLY
REVIEWED BY: ROBERT BABB USARC G-6 RCDD	

USARC G-6
NETWORKING AND
INFRASTRUCTURE
BRANCH
INFRASTRUCTURE
TEAM

U.S. ARMY RESERVE
NETWORK ENTERPRISE CENTER
INFRASTRUCTURE
TECHNICAL CRITERIA
DIAGRAM AND DETAILS

B.01

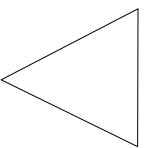
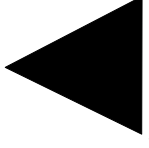
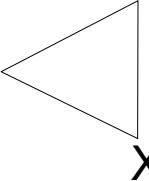
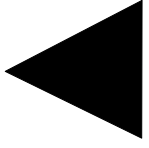
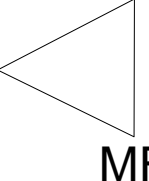
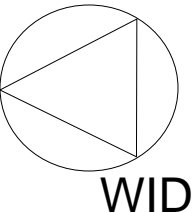
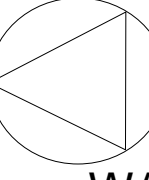
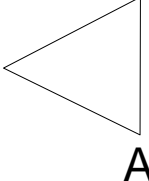
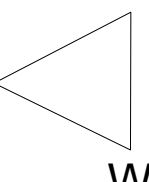
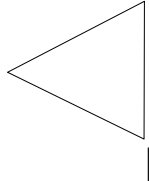
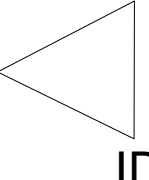
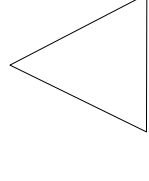
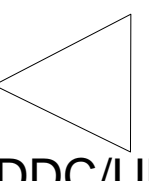

SYMBOL	DESCRIPTION	SYMBOL	DESCRIPTION
	ICT OUTLET (1 JACK)	 W	ICT OUTLET(1 JACK) 2 LUG WALL PHONE FACEPLATE
	ICT OUTLET ("X" DENOTES NUMBER OF JACKS)	 CB	EXTERIOR CALL BOX (1 JACK)
	MULTI-FUNCTIONAL DEVICE ICT OUTLET (2 JACKS)		WID ICT OUTLET ACCESSIBLE (I.E. STANDARD DROP) CEILING (2 JACKS)
	WAP ICT OUTLET ACCESSIBLE (I.E. STANDARD DROP) CEILING (2 JACKS)		ICT OUTLET (2 JACKS) MOUNT 6 INCHES ABOVE COUNTER TOP
	WAP ICT OUTLET NON- ACCESSIBLE (I.E. HARD /HIGH HEIGHT) CEILING (2 JACKS)		MODULAR FURNITURE ICT OUTLET (1 JACK)
	IDS PANEL (2 JACKS)		SIPRNET OUTLET (1 JACK)
	DDC/UMP ICT OUTLET (1 JACK) MOUNT AS CLOSE TO THE CONTROL PANEL AS POSSIBLE		

SYMBOL	REVISIONS DESCRIPTION	DATE	APPR.

DESIGNED BY:
JOHN BABB

DESIGNED BY:
DEREK MITCHELL

REVIEWED BY:
ROBERT BABB
USARC G-6 RCDD

DATE:
JUNE 2016

FOR
OFFICIAL
USE ONLY

USARC G-6
NETWORKING AND
INFRASTRUCTURE
BRANCH
INFRASTRUCTURE
TEAM

U.S. ARMY RESERVE
NETWORK ENTERPRISE CENTER
INFRASTRUCTURE
TECHNICAL CRITERIA
DIAGRAM AND DETAILS

B.02

STANDARD TELECOMMUNICATIONS SYMBOL LEGEND

SHEET KEY NOTES

- 1 PLYWOOD SHALL BE INSTALLED SO THAT THE A GRADE SIDE FACES INTO THE ROOM. MOUNT AT 8 INCHES AFF. DO NOT PAINT. AT LEAST ONE FIRE RATED STAMP IS TO BE VISIBLE ON EACH SHEET OF PLYWOOD
- 2 SPACE RESERVED FOR SERVICE PROVIDER INSTALLED EQUIPMENT
- 3 SERVICE PROVIDER INSTALLED BUILDING ENTRANCE PROTECTOR FOR COPPER BACKBONE CABLE
- 4 SERVICE PROVIDER INSTALLED COPPER TERMINATION BLOCK
- 5 SERVICE PROVIDER INSTALLED WALL MOUNTED FOPP
- 6 SERVICE PROVIDER INSTALLED COPPER BACKBONE CABLE
- 7 SERVICE PROVIDER INSTALLED SM FOC
- 8 DOUBLE DUPLEX NEMA 5-20R POWER RECEPTACLE
- 9 NEMA L5-15R POWER RECEPTACLE
- 10 TMGB/TGB
- 11 HORIZONTAL LADDER RACK
- 12 CABLE RADIUS DROP OUTS (WATERFALL SUPPORTS)
- 13 LEC AND CATV PROVIDER CONDUIT
- 14 DS3 EXTENSION COAXIAL CABLE
- 15 STANDARD WALL SLEEVES OR SELF-SEALING, RE-ENTERABLE, MECHANICAL FIRE-STOPPING WALL SLEEVES (AS REQUIRED PER TECHNICAL CRITERIA)
- 16 12 PORT WALL MOUNTED CAT6 PATCH PANEL
- 17 (12) CATEGORY 6 CABLES FROM TER
- 18 VERTICAL LADDER RACK

SHEET GENERAL NOTES

1. ALL DIAGRAMS ILLUSTRATE REQUIRED COMPONENTS AS WELL AS MOUNTING AND SPACING DETAILS FOR THESE COMPONENTS. DIAGRAMS ALSO ILLUSTRATE THE PREFERRED LAYOUT FOR THESE COMPONENTS BASED ON STANDARD ROOM LAYOUTS. THE DIAGRAMS DO NOT NECESSARILY ILLUSTRATE THE QUANTITY REQUIRED OF EACH COMPONENT NOR THE ACTUAL LOCATION FOR THESE COMPONENTS. EXACT QUANTITY AND LOCATION WILL BE DETERMINED DURING THE DESIGN AND CONSTRUCTION PROCESSES.

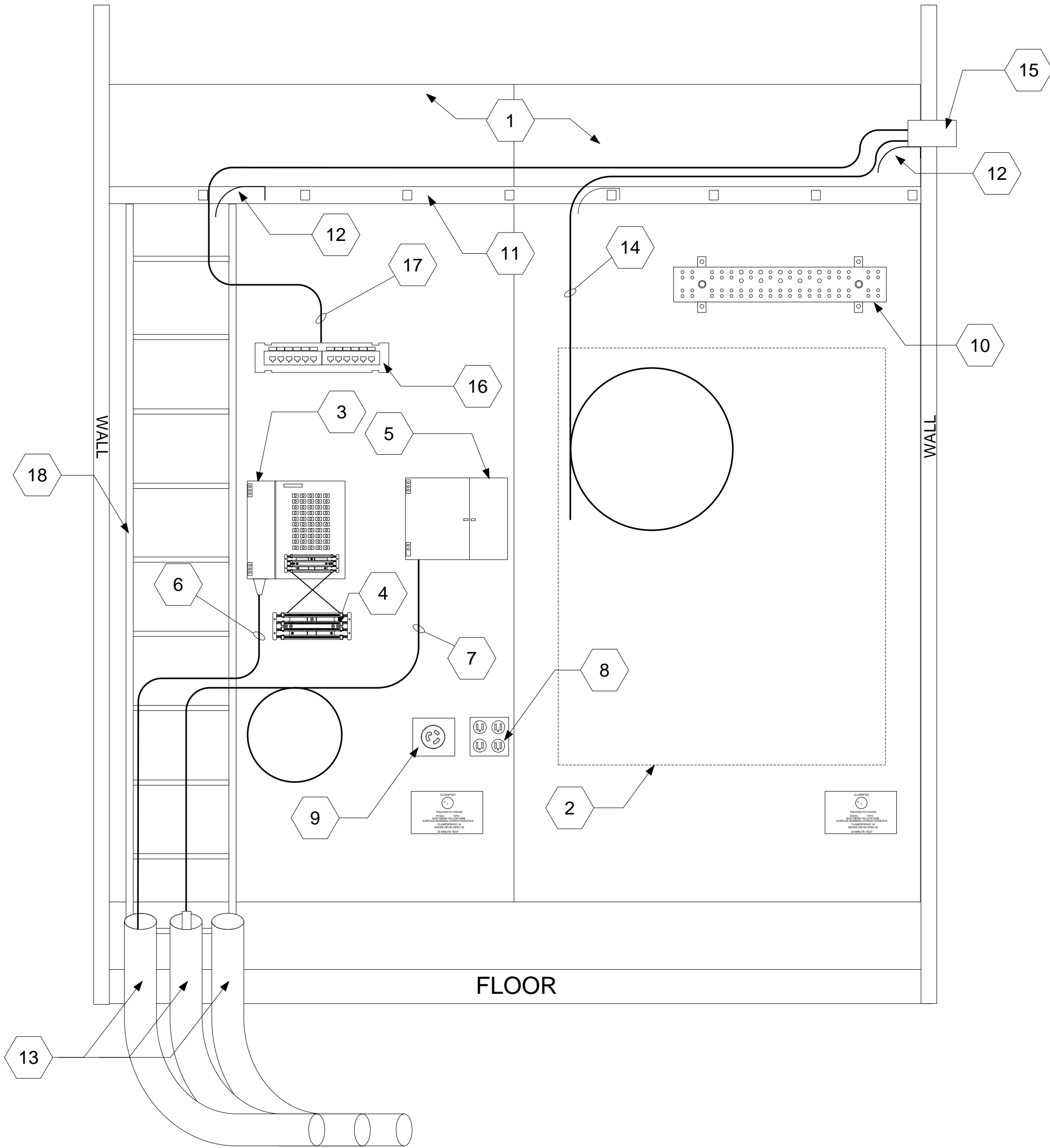

REVISIONS	DATE	APPR.
SYMBOL		

DESIGNED BY:	DATE:	FOR
JOHN BABB	JUNE 2016	OFFICIAL USE ONLY
DESIGNED BY:		
DEREK MITCHELL		
REVIEWED BY:		
ROBERT BABB		
USARC G-6 RCDD		

USARC G-6 NETWORKING AND INFRASTRUCTURE BRANCH INFRASTRUCTURE TEAM

U.S. ARMY RESERVE NETWORK ENTERPRISE CENTER INFRASTRUCTURE TECHNICAL CRITERIA DIAGRAM AND DETAILS

B.03

 TYPICAL EF WALL ELEVATION DIAGRAM

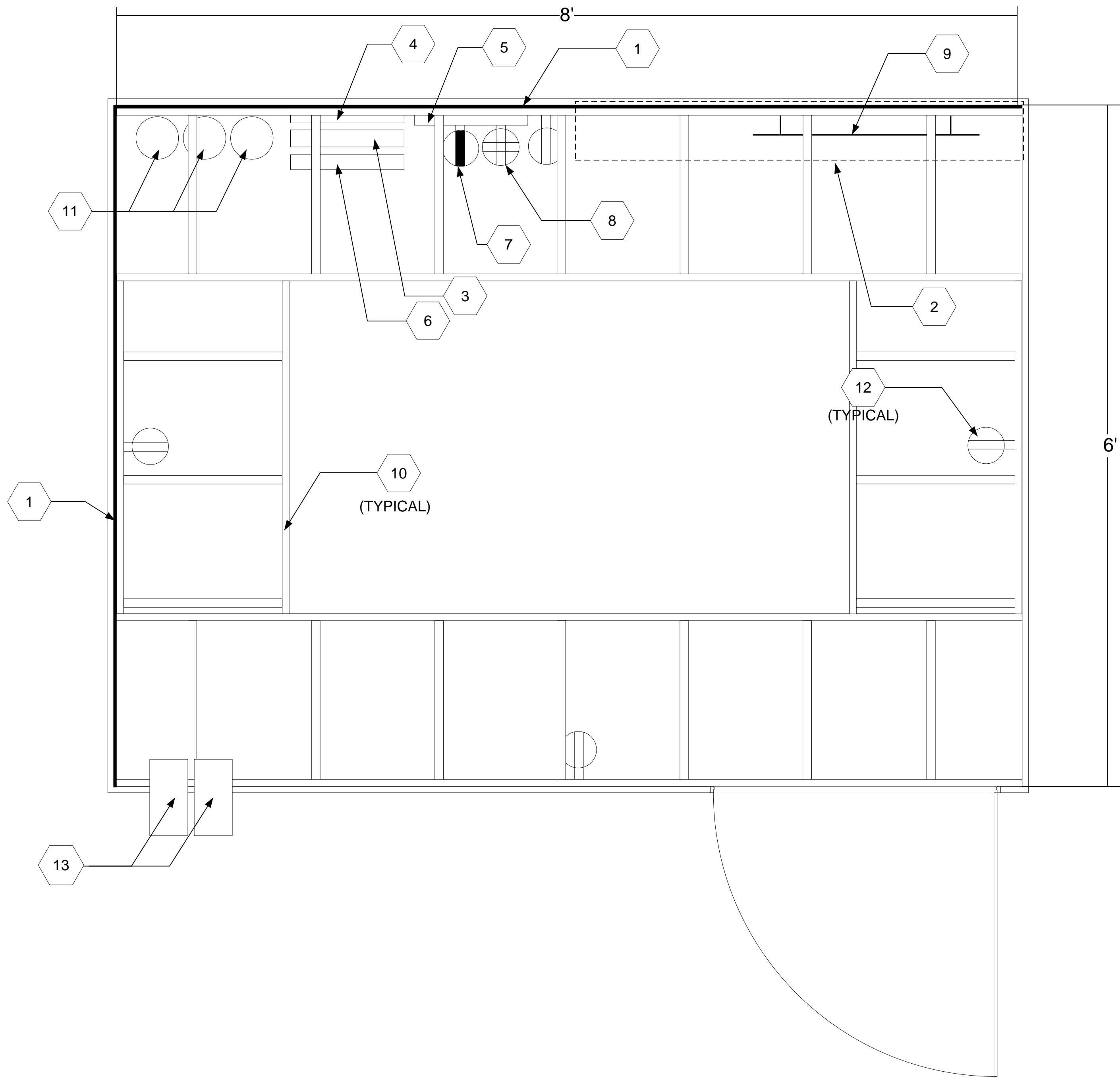

SHEET KEY NOTES

- 1 PLYWOOD SHALL BE INSTALLED SO THAT THE A GRADE SIDE FACES INTO THE ROOM. MOUNT AT 8 INCHES AFF. DO NOT PAINT. AT LEAST ONE FIRE RATED STAMP IS TO BE VISIBLE ON EACH SHEET OF PLYWOOD
- 2 SPACE RESERVED FOR SERVICE PROVIDER INSTALLED EQUIPMENT
- 3 SERVICE PROVIDER INSTALLED BUILDING ENTRANCE PROTECTOR FOR COPPER BACKBONE CABLE
- 4 SERVICE PROVIDER INSTALLED COPPER TERMINATION BLOCK
- 5 SERVICE PROVIDER INSTALLED WALL MOUNTED FOPP
- 6 12 PORT WALL MOUNTED CAT6 PATCH PANEL
- 7 NEMA L5-15R POWER RECEPTACLE
- 8 DOUBLE DUPLEX NEMA 5-20R POWER RECEPTACLE
- 9 TMGB/TGB
- 10 HORIZONTAL LADDER RACK
- 11 LEC AND CATV PROVIDER CONDUIT
- 12 NEMA 5-20 DUPLEX CONVENIENCE RECEPTACLE
- 13 STANDARD WALL SLEEVES OR SELF-SEALING, RE-ENTERABLE, MECHANICAL FIRE-STOPPING WALL SLEEVES (AS REQUIRED PER TECHNICAL CRITERIA)

SHEET GENERAL NOTES

1. ALL DIAGRAMS ILLUSTRATE REQUIRED COMPONENTS AS WELL AS MOUNTING AND SPACING DETAILS FOR THESE COMPONENTS. DIAGRAMS ALSO ILLUSTRATE THE PREFERRED LAYOUT FOR THESE COMPONENTS BASED ON STANDARD ROOM LAYOUTS. THE DIAGRAMS DO NOT NECESSARILY ILLUSTRATE THE QUANTITY REQUIRED OF EACH COMPONENT NOR THE ACTUAL LOCATION FOR THESE COMPONENTS. EXACT QUANTITY AND LOCATION WILL BE DETERMINED DURING THE DESIGN AND CONSTRUCTION PROCESSES.



REVISIONS	DATE	APPR.

DESIGNED BY: JOHN BABB
 DESIGNED BY: DEREK MITCHELL
 REVIEWED BY: ROBERT BABB
 USARC G-6 RCDD

USARC G-6
 NETWORKING AND
 INFRASTRUCTURE
 BRANCH
 INFRASTRUCTURE
 TEAM

U.S. ARMY RESERVE
 NETWORK ENTERPRISE CENTER
 INFRASTRUCTURE
 TECHNICAL CRITERIA
 DIAGRAM AND DETAILS

B.04

TYPICAL EF AERIAL DIAGRAM

SHEET KEY NOTES

- 1 2 POST EQUIPMENT RACK
- 2 2U HORIZONTAL WIRE MANAGER
- 3 4U FIBER PATCH PANEL
- 4 48 PORT PATCH PANEL
- 5 VERTICAL WIRE MANAGER
- 6 12 PORT PATCH PANEL
- 7 HORIZONTAL LADDER RACK
- 8 (12) CAT 6 CABLES TO EF
- 9 12 STRAND SM FOC TO OTHER TR(S)
- 10 SIAMESE COAXIAL CABLE

SHEET GENERAL NOTES

1. ALL DIAGRAMS ILLUSTRATE REQUIRED COMPONENTS AS WELL AS MOUNTING AND SPACING DETAILS FOR THESE COMPONENTS. DIAGRAMS ALSO ILLUSTRATE THE PREFERRED LAYOUT FOR THESE COMPONENTS BASED ON STANDARD ROOM LAYOUTS. THE DIAGRAMS DO NOT NECESSARILY ILLUSTRATE THE QUANTITY REQUIRED OF EACH COMPONENT NOR THE ACTUAL LOCATION FOR THESE COMPONENTS. EXACT QUANTITY AND LOCATION WILL BE DETERMINED DURING THE DESIGN AND CONSTRUCTION PROCESSES.



REVISIONS	DATE	APPR.

DESIGNED BY: JOHN BABB	DATE: JUNE 2016	FOR OFFICIAL USE ONLY
DESIGNED BY: DEREK MITCHELL		
REVIEWED BY: ROBERT BABB USARC G-6 RCDD		

USARC G-6
NETWORKING AND
INFRASTRUCTURE
BRANCH
INFRASTRUCTURE
TEAM

U.S. ARMY RESERVE
NETWORK ENTERPRISE CENTER
INFRASTRUCTURE
TECHNICAL CRITERIA
DIAGRAM AND DETAILS

B.05

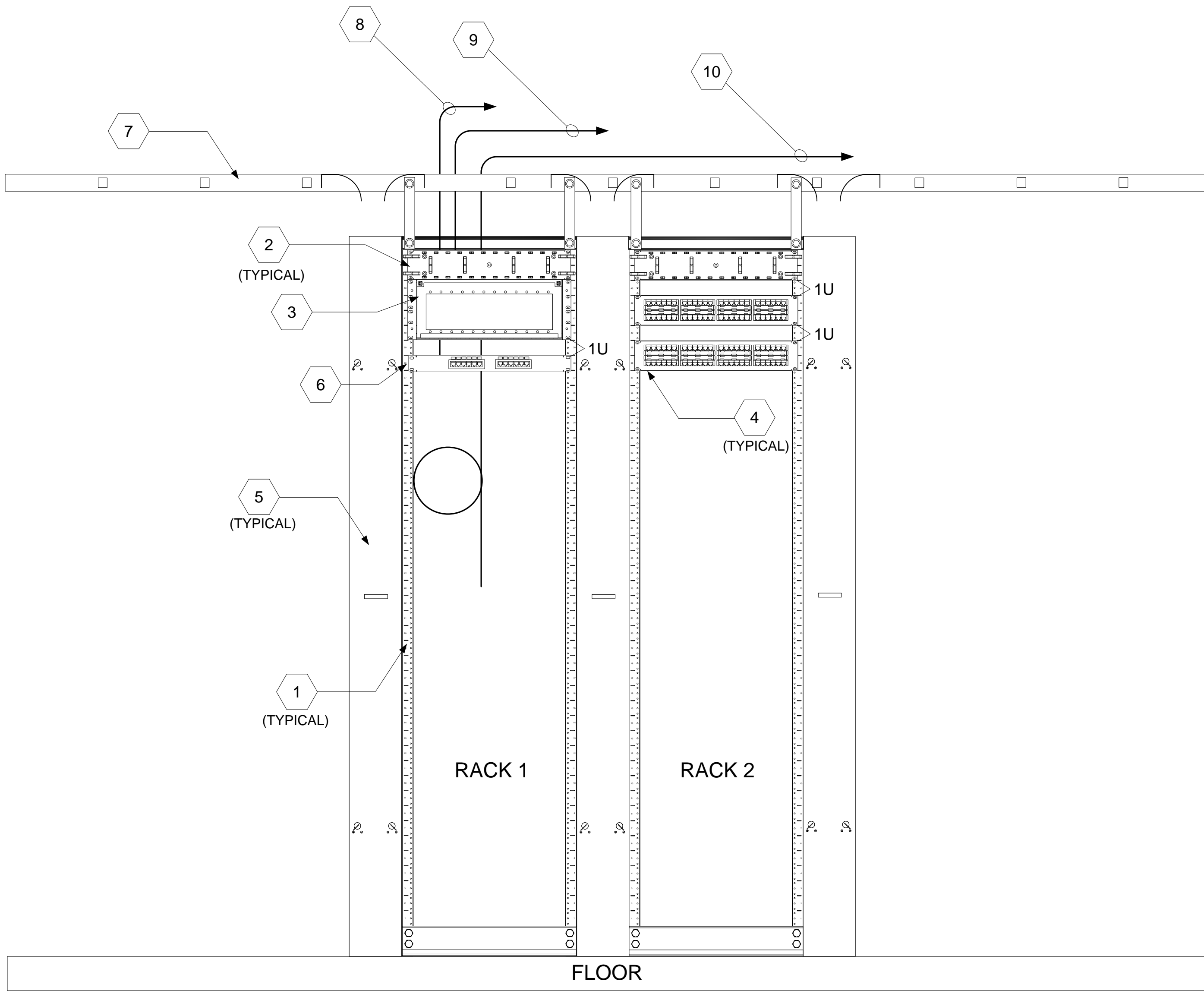

TYPICAL TER RACK FRONT ELEVATION DIAGRAM

SHEET GENERAL NOTES

1. ALL DIAGRAMS ILLUSTRATE REQUIRED COMPONENTS AS WELL AS MOUNTING AND SPACING DETAILS FOR THESE COMPONENTS. DIAGRAMS ALSO ILLUSTRATE THE PREFERRED LAYOUT FOR THESE COMPONENTS BASED ON STANDARD ROOM LAYOUTS. THE DIAGRAMS DO NOT NECESSARILY ILLUSTRATE THE QUANTITY REQUIRED OF EACH COMPONENT NOR THE ACTUAL LOCATION FOR THESE COMPONENTS. EXACT QUANTITY AND LOCATION WILL BE DETERMINED DURING THE DESIGN AND CONSTRUCTION PROCESSES.

SHEET KEY NOTES

- 1 DOUBLE DUPLEX NEMA 5-20R RECEPTACLE
- 2 RACK MOUNTED BUS-BAR (RGB)
- 3 HORIZONTAL LADDER RACK

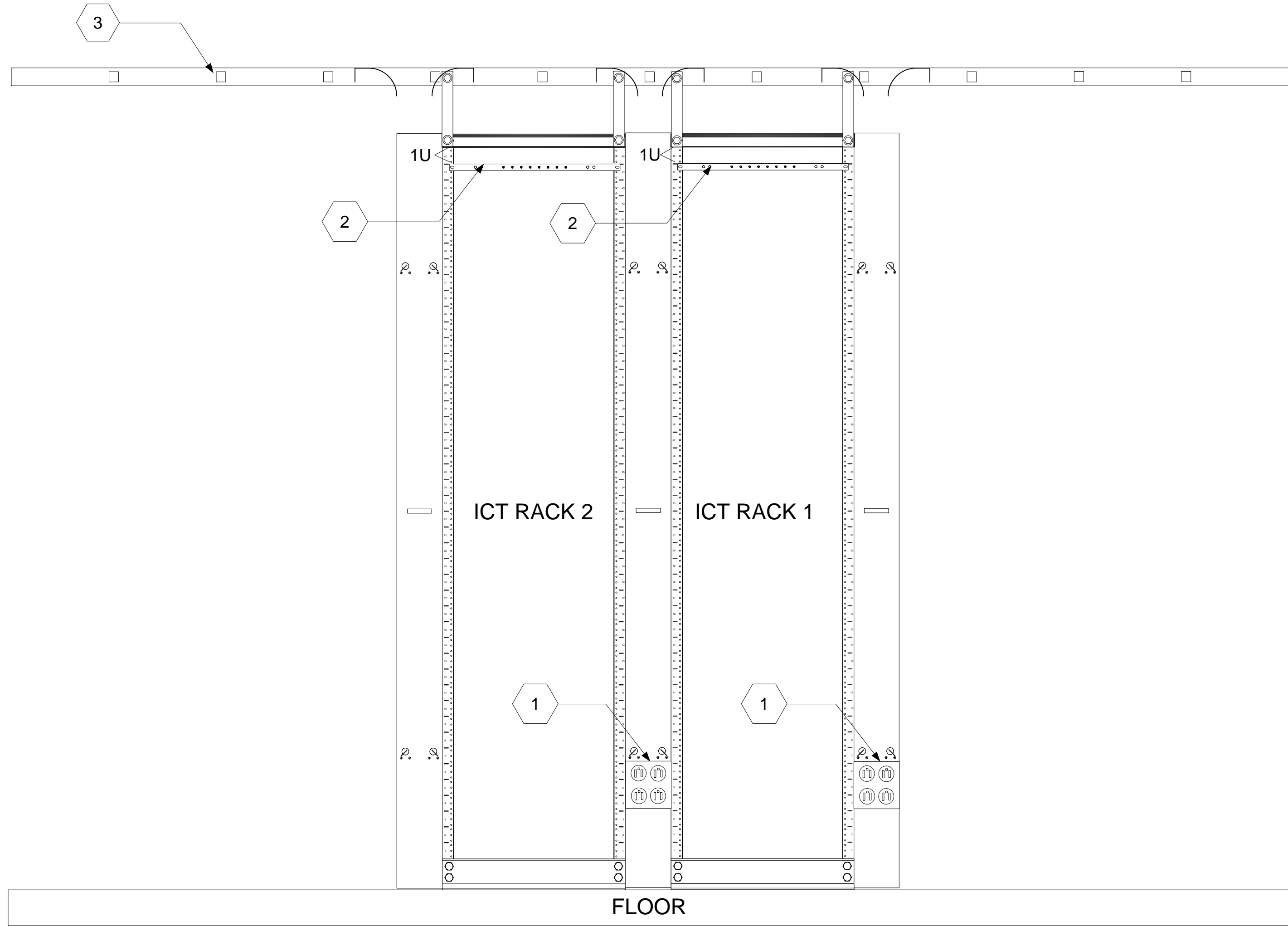

SYMBOL	REVISIONS DESCRIPTION	DATE	APPR.

DESIGNED BY: JOHN BABB	DATE: JUNE 2016
DESIGNED BY: DEREK MITCHELL	FOR OFFICIAL USE ONLY
REVIEWED BY: ROBERT BABB	
USARC G-6 RCDD	

USARC G-6
NETWORKING AND
INFRASTRUCTURE
BRANCH
INFRASTRUCTURE
TEAM

U.S. ARMY RESERVE
NETWORK ENTERPRISE CENTER
INFRASTRUCTURE
TECHNICAL CRITERIA
DIAGRAM AND DETAILS

B.06

TYPICAL TER RACK REAR ELEVATION DIAGRAM

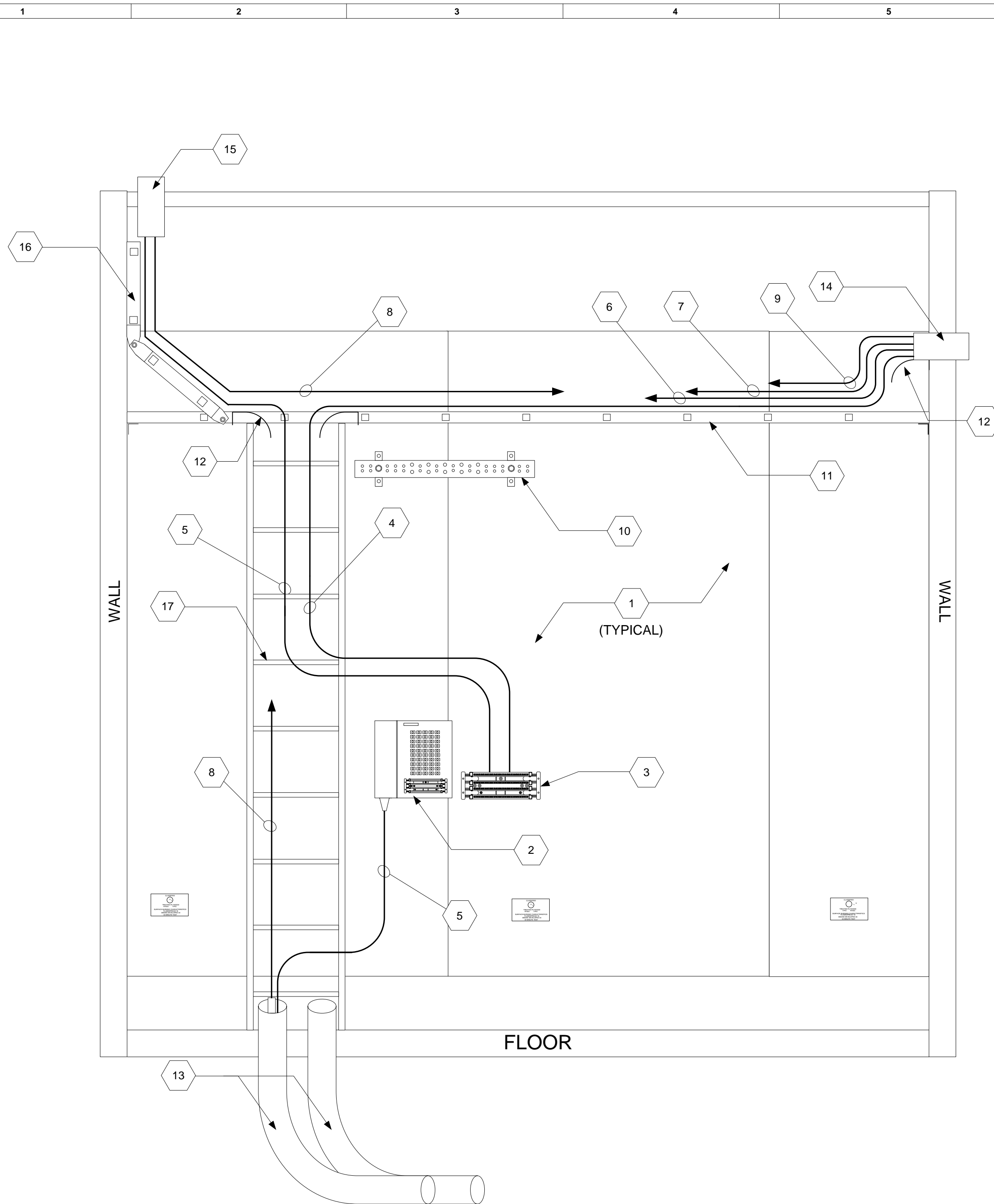

SHEET KEY NOTES

- 1 PLYWOOD SHALL BE INSTALLED SO THAT THE A GRADE SIDE FACES INTO THE ROOM. MOUNT AT 8 INCHES AFF. DO NOT PAINT. AT LEAST ONE FIRE RATED STAMP IS TO BE VISIBLE ON EACH SHEET OF PLYWOOD
- 2 BUILDING ENTRANCE PROTECTOR FOR BACKBONE COPPER TO OMS TR (IF REQUIRED)
- 3 110 BLOCK FOR BACKBONE COPPER TO TR XXX (IF REQUIRED)
- 4 COPPER BACKBONE CABLE TO TR XXX (IF REQUIRED)
- 5 COPPER BACKBONE CABLE TO OMS TR XXX (IF REQUIRED)
- 6 (12) CAT 6 CABLES FROM THE EF
- 7 FIBER OPTIC BACKBONE CABLE TO TR XXX (IF REQUIRED)
- 8 FIBER OPTIC BACKBONE CABLE TO OMS TR XXX (IF REQUIRED)
- 9 DS3 EXTENSION COAXIAL CABLE
- 10 TMGB/TGB
- 11 HORIZONTAL LADDER RACK
- 12 CABLE RADIUS DROP OUTS (WATERFALL SUPPORTS)
- 13 CONDUITS TO THE OMS TR
- 14 STANDARD WALL SLEEVES OR SELF-SEALING, RE-ENTERABLE, MECHANICAL FIRE-STOPPING WALL SLEEVES (AS REQUIRED PER TECHNICAL CRITERIA)
- 15 SELF-SEALING, RE-ENTERABLE, MECHANICAL FIRE-STOPPING FLOOR SLEEVES
- 16 VERTICAL 18 INCH WIDE LADDER RACK
- 17 VERTICAL 12 INCH WIDE LADDER RACK

SHEET GENERAL NOTES

1. ALL DIAGRAMS ILLUSTRATE REQUIRED COMPONENTS AS WELL AS MOUNTING AND SPACING DETAILS FOR THESE COMPONENTS. DIAGRAMS ALSO ILLUSTRATE THE PREFERRED LAYOUT FOR THESE COMPONENTS BASED ON STANDARD ROOM LAYOUTS. THE DIAGRAMS DO NOT NECESSARILY ILLUSTRATE THE QUANTITY REQUIRED OF EACH COMPONENT NOR THE ACTUAL LOCATION FOR THESE COMPONENTS. EXACT QUANTITY AND LOCATION WILL BE DETERMINED DURING THE DESIGN AND CONSTRUCTION PROCESSES.



REVISIONS	DATE	APPR.

DESIGNED BY:	DATE:	FOR
JOHN BABB	JUNE 2016	OFFICIAL USE ONLY
DESIGNED BY: DEREK MITCHELL		
REVIEWED BY: ROBERT BABB		
USARC G-6 RCDD		

USARC G-6
NETWORKING AND
INFRASTRUCTURE
BRANCH
INFRASTRUCTURE
TEAM

U.S. ARMY RESERVE
NETWORK ENTERPRISE CENTER
INFRASTRUCTURE
TECHNICAL CRITERIA
DIAGRAM AND DETAILS

B.07

TYPICAL TER WALL ELEVATION DIAGRAM

SHEET KEY NOTES

- 1 PLYWOOD SHALL BE INSTALLED SO THAT THE A GRADE SIDE FACES INTO THE ROOM. MOUNT AT 8 INCHES AFF. DO NOT PAINT. AT LEAST ONE FIRE RATED STAMP IS TO BE VISIBLE ON EACH SHEET OF PLYWOOD
- 2 BUILDING ENTRANCE PROTECTOR FOR BACKBONE COPPER TO OMS TR (IF REQUIRED)
- 3 110 BLOCK FOR BACKBONE COPPER (IF REQUIRED)
- 4 NEMA 5-20 DUPLEX CONVENIENCE RECEPTACLE
- 5 TMGB/TGB
- 6 HORIZONTAL LADDER RACK
- 7 CONDUITS TO OMS TR
- 8 TELECOMMUNICATIONS EQUIPMENT RACK
- 9 VERTICAL WIRE MANAGERS
- 10 EQUIPMENT RACK RECEPTACLE
- 11 STANDARD WALL SLEEVES OR SELF-SEALING, RE-ENTERABLE, MECHANICAL FIRE-STOPPING WALL SLEEVES (AS REQUIRED PER TECHNICAL CRITERIA)

SHEET GENERAL NOTES

1. ALL DIAGRAMS ILLUSTRATE REQUIRED COMPONENTS AS WELL AS MOUNTING AND SPACING DETAILS FOR THESE COMPONENTS. DIAGRAMS ALSO ILLUSTRATE THE PREFERRED LAYOUT FOR THESE COMPONENTS BASED ON STANDARD ROOM LAYOUTS. THE DIAGRAMS DO NOT NECESSARILY ILLUSTRATE THE QUANTITY REQUIRED OF EACH COMPONENT NOR THE ACTUAL LOCATION FOR THESE COMPONENTS. EXACT QUANTITY AND LOCATION WILL BE DETERMINED DURING THE DESIGN AND CONSTRUCTION PROCESSES.



REVISIONS	DATE	APPR.

DESIGNED BY: JOHN BABB	DATE: JUNE 2016	FOR OFFICIAL USE ONLY
DESIGNED BY: DEREK MITCHELL		
REVIEWED BY: ROBERT BABB		
		USARC G-6 RCDD

USARC G-6
NETWORKING AND
INFRASTRUCTURE
BRANCH
INFRASTRUCTURE
TEAM

U.S. ARMY RESERVE
NETWORK ENTERPRISE CENTER
INFRASTRUCTURE
TECHNICAL CRITERIA
DIAGRAM AND DETAILS

B.08

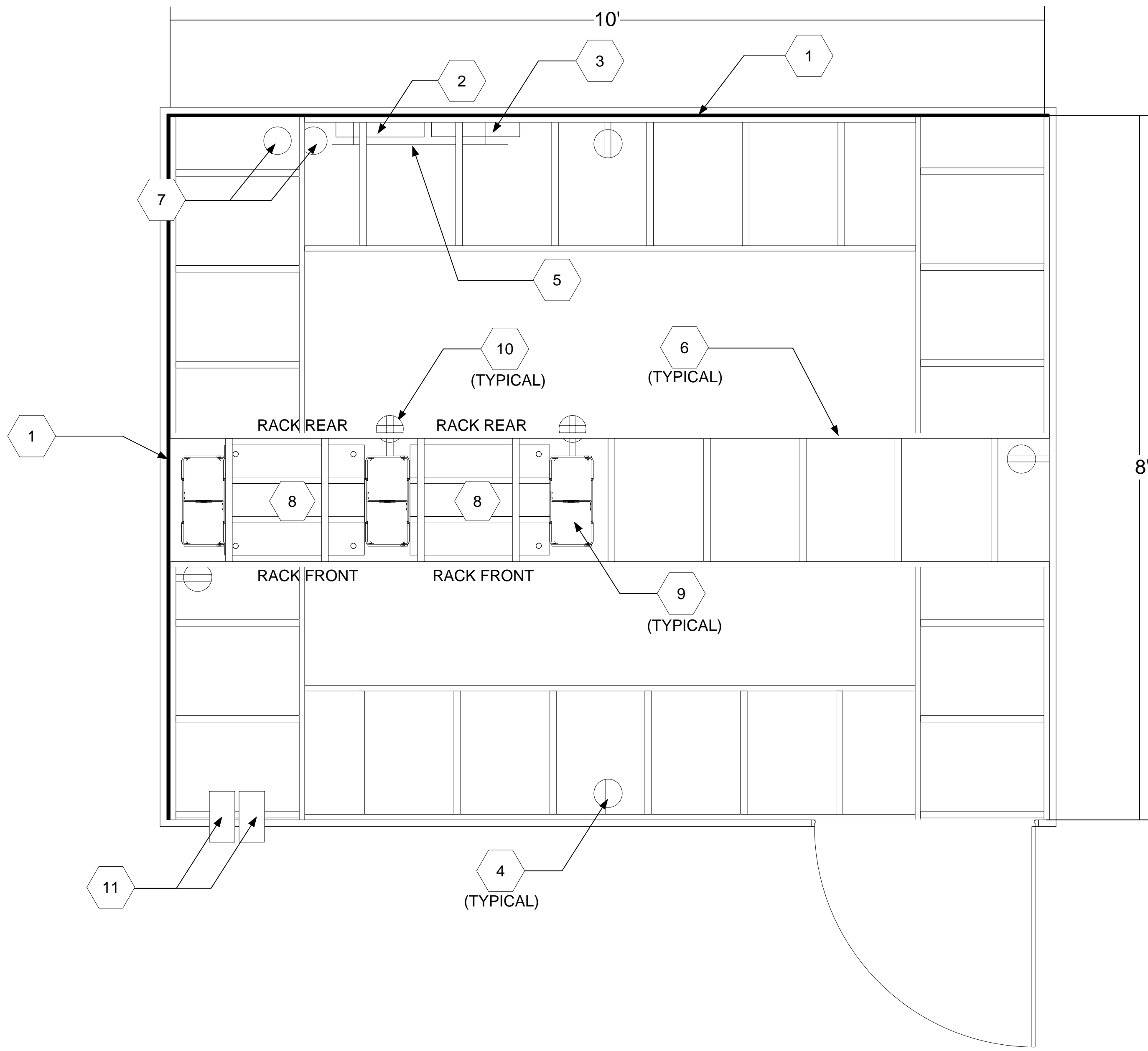

TYPICAL TER AERIAL DIAGRAM

SHEET GENERAL NOTES

1. ALL DIAGRAMS ILLUSTRATE REQUIRED COMPONENTS AS WELL AS MOUNTING AND SPACING DETAILS FOR THESE COMPONENTS. DIAGRAMS ALSO ILLUSTRATE THE PREFERRED LAYOUT FOR THESE COMPONENTS BASED ON STANDARD ROOM LAYOUTS. THE DIAGRAMS DO NOT NECESSARILY ILLUSTRATE THE QUANTITY REQUIRED OF EACH COMPONENT NOR THE ACTUAL LOCATION FOR THESE COMPONENTS. EXACT QUANTITY AND LOCATION WILL BE DETERMINED DURING THE DESIGN AND CONSTRUCTION PROCESSES.

SHEET KEY NOTES

- 1 2 POST EQUIPMENT RACK
- 2 2U HORIZONTAL WIRE MANAGER
- 3 2U FIBER PATCH PANEL
- 4 48 PORT PATCH PANEL
- 5 VERTICAL WIRE MANAGER
- 6 HORIZONTAL LADDER RACK
- 7 12 STRAND SM FOC TO THE TER

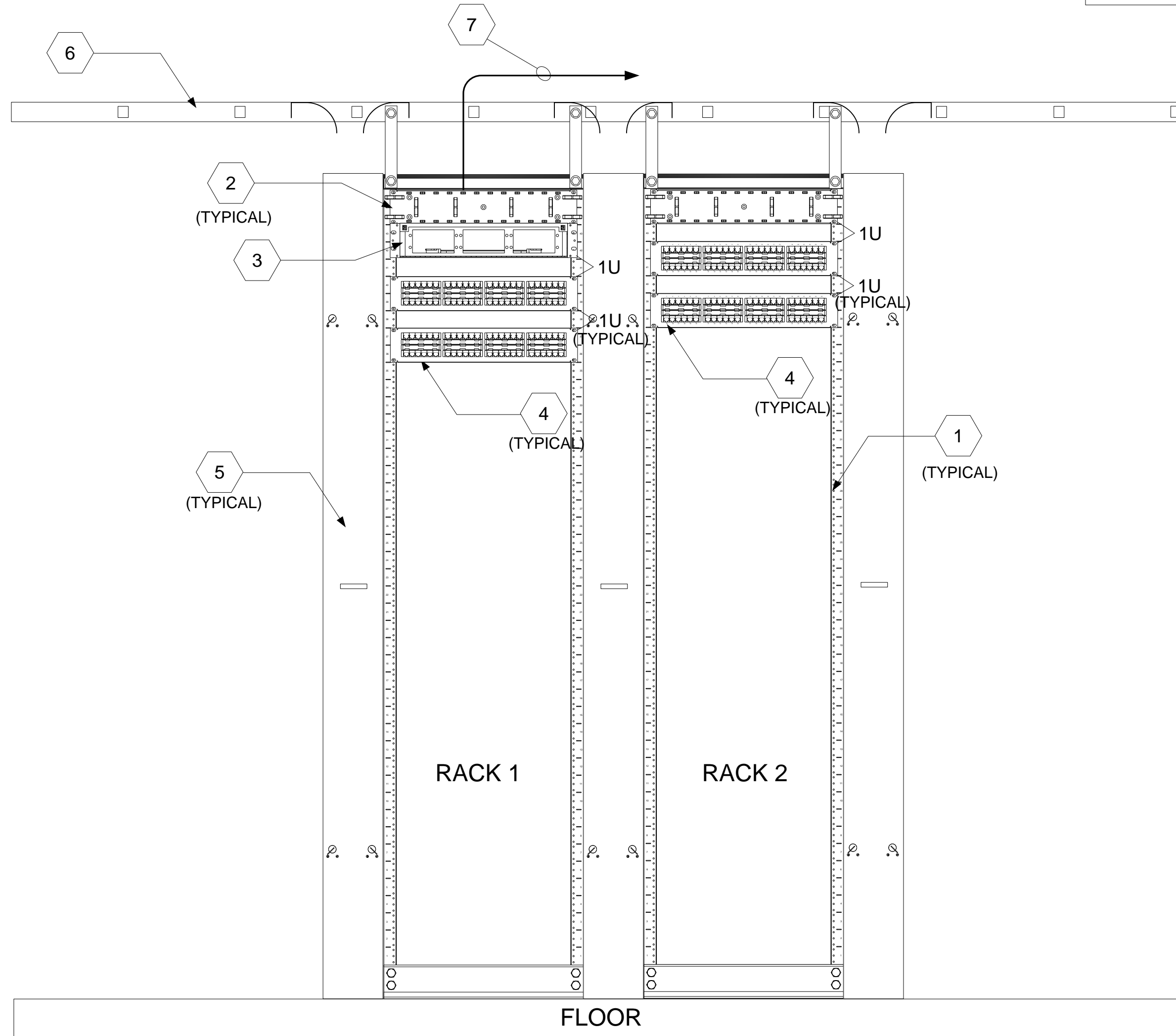

TYPICAL STANDARD TR RACK FRONT ELEVATION DIAGRAM



REVISIONS	DATE	APPR.

DESIGNED BY: JOHN BABB	DATE: JUNE 2016
DESIGNED BY: DEREK MITCHELL	FOR OFFICIAL USE ONLY
REVIEWED BY: ROBERT BABB	
USARC G-6 RCDD	

USARC G-6
NETWORKING AND
INFRASTRUCTURE
BRANCH
INFRASTRUCTURE
TEAM

U.S. ARMY RESERVE
NETWORK ENTERPRISE CENTER
INFRASTRUCTURE
TECHNICAL CRITERIA
DIAGRAM AND DETAILS

B.09

SHEET GENERAL NOTES

1. ALL DIAGRAMS ILLUSTRATE REQUIRED COMPONENTS AS WELL AS MOUNTING AND SPACING DETAILS FOR THESE COMPONENTS. DIAGRAMS ALSO ILLUSTRATE THE PREFERRED LAYOUT FOR THESE COMPONENTS BASED ON STANDARD ROOM LAYOUTS. THE DIAGRAMS DO NOT NECESSARILY ILLUSTRATE THE QUANTITY REQUIRED OF EACH COMPONENT NOR THE ACTUAL LOCATION FOR THESE COMPONENTS. EXACT QUANTITY AND LOCATION WILL BE DETERMINED DURING THE DESIGN AND CONSTRUCTION PROCESSES.

SHEET KEY NOTES

- 1 DOUBLE DUPLEX NEMA 5-20R RECEPTACLE
- 2 RACK MOUNTED BUS-BAR (RGB)
- 3 HORIZONTAL LADDER RACK

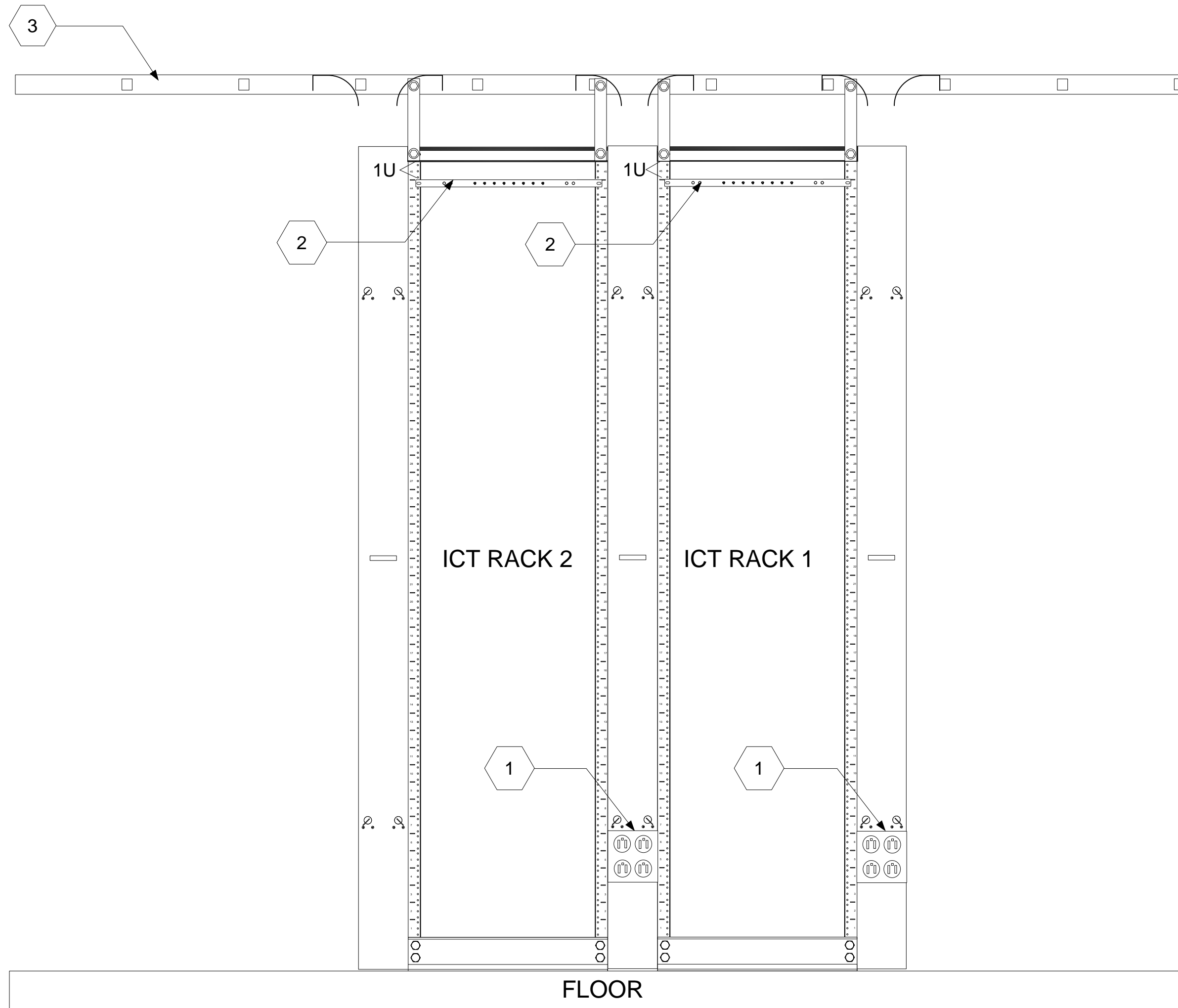

TYPICAL STANDARD TR RACK REAR ELEVATION DIAGRAM



SYMBOL	REVISIONS DESCRIPTION	DATE	APPR.

DESIGNED BY: JOHN BABB	DATE: JUNE 2016
DESIGNED BY: DEREK MITCHELL	FOR OFFICIAL USE ONLY
REVIEWED BY: ROBERT BABB	
USARC G-6 RCDD	

USARC G-6
NETWORKING AND
INFRASTRUCTURE
BRANCH
INFRASTRUCTURE
TEAM

U.S. ARMY RESERVE
NETWORK ENTERPRISE CENTER
INFRASTRUCTURE
TECHNICAL CRITERIA
DIAGRAM AND DETAILS

B.10

SHEET KEY NOTES

- 1 PLYWOOD SHALL BE INSTALLED SO THAT THE A GRADE SIDE FACES INTO THE ROOM. MOUNT AT 8 INCHES AFF. DO NOT PAINT. AT LEAST ONE FIRE RATED STAMP IS TO BE VISIBLE ON EACH SHEET OF PLYWOOD
- 2 110 BLOCK FOR COPPER BACKBONE CABLE TO TER
- 3 COPPER BACKBONE CABLE TO TER
- 4 FIBER OPTIC BACKBONE CABLE TO TER
- 5 STANDARD WALL SLEEVES OR SELF-SEALING, RE-ENTERABLE, MECHANICAL FIRE-STOPPING WALL SLEEVES (AS REQUIRED PER TECHNICAL CRITERIA)
- 6 TMGB/TGB
- 7 HORIZONTAL LADDER RACK
- 8 CABLE RADIUS DROP OUTS (WATERFALL SUPPORTS)
- 9 VERTICAL LADDER RACK

SHEET GENERAL NOTES

1. ALL DIAGRAMS ILLUSTRATE REQUIRED COMPONENTS AS WELL AS MOUNTING AND SPACING DETAILS FOR THESE COMPONENTS. DIAGRAMS ALSO ILLUSTRATE THE PREFERRED LAYOUT FOR THESE COMPONENTS BASED ON STANDARD ROOM LAYOUTS. THE DIAGRAMS DO NOT NECESSARILY ILLUSTRATE THE QUANTITY REQUIRED OF EACH COMPONENT NOR THE ACTUAL LOCATION FOR THESE COMPONENTS. EXACT QUANTITY AND LOCATION WILL BE DETERMINED DURING THE DESIGN AND CONSTRUCTION PROCESSES.

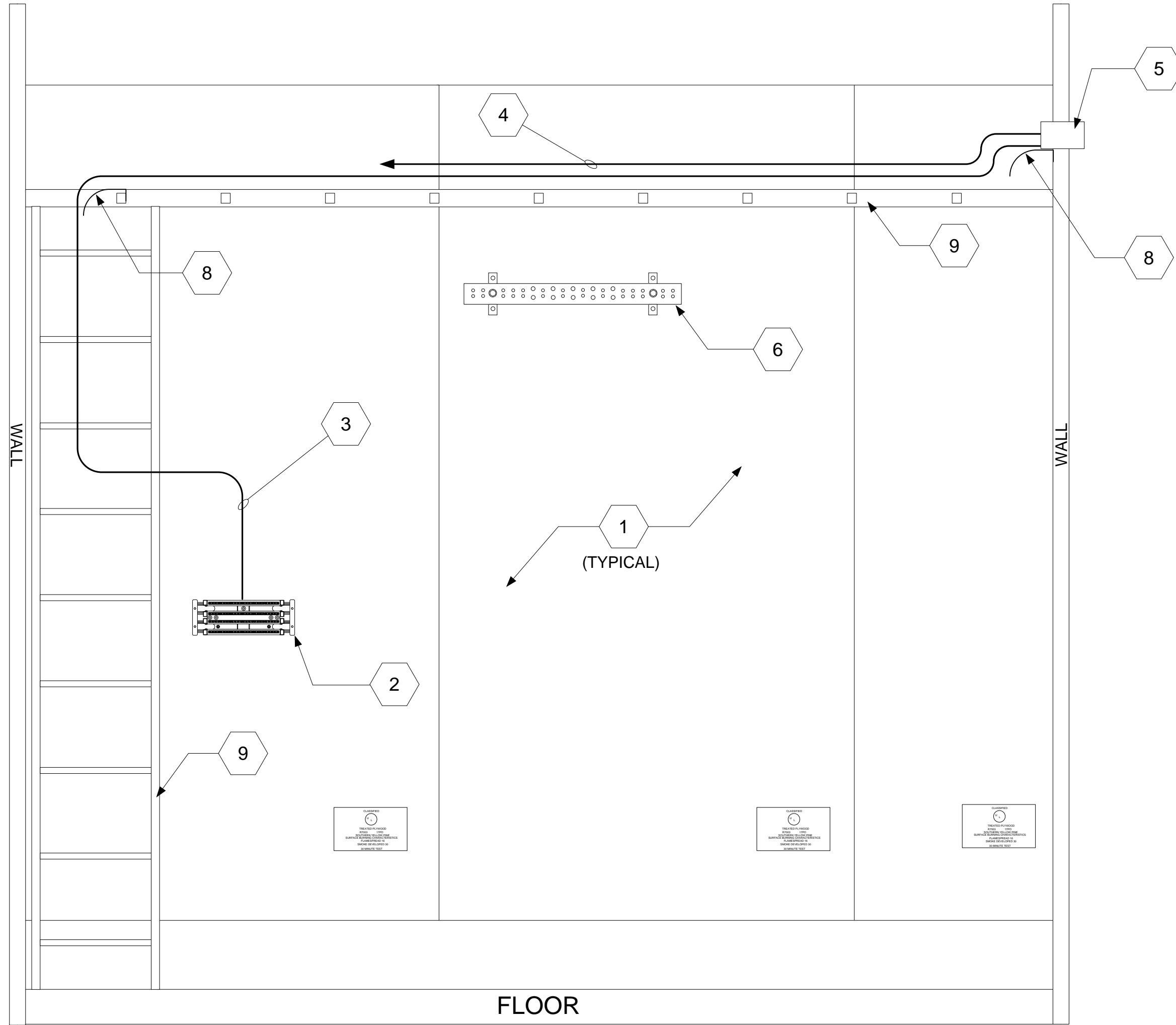

REVISIONS	DATE	APPR.
SYMBOL		

DESIGNED BY: JOHN BABB	DATE: JUNE 2016	FOR OFFICIAL USE ONLY
DESIGNED BY: DEREK MITCHELL		
REVIEWED BY: ROBERT BABB		
USARC G-6 RCDD		

USARC G-6
NETWORKING AND
INFRASTRUCTURE
BRANCH
INFRASTRUCTURE
TEAM

U.S. ARMY RESERVE
NETWORK ENTERPRISE CENTER
INFRASTRUCTURE
TECHNICAL CRITERIA
DIAGRAM AND DETAILS

B.11

TYPICAL FIRST FLOOR STANDARD TR WALL ELEVATION DIAGRAM

SHEET KEY NOTES

- 1 PLYWOOD SHALL BE INSTALLED SO THAT THE A GRADE SIDE FACES INTO THE ROOM. MOUNT AT 8 INCHES AFF. DO NOT PAINT. AT LEAST ONE FIRE RATED STAMP IS TO BE VISIBLE ON EACH SHEET OF PLYWOOD
- 2 110 BLOCK FOR COPPER BACKBONE CABLE TO TER
- 3 COPPER BACKBONE CABLE TO TER
- 4 FIBER OPTIC BACKBONE CABLE TO TER
- 5 STANDARD WALL SLEEVES OR SELF-SEALING, RE-ENTERABLE, MECHANICAL FIRE-STOPPING WALL SLEEVES (AS REQUIRED PER TECHNICAL CRITERIA)
- 6 SELF-SEALING, RE-ENTERABLE, MECHANICAL FIRE-STOPPING FLOOR SLEEVES
- 7 TMGB/TGB
- 8 HORIZONTAL LADDER RACK
- 9 CABLE RADIUS DROP OUTS (WATERFALL SUPPORTS)
- 10 VERTICAL LADDER RACK

SHEET GENERAL NOTES

1. ALL DIAGRAMS ILLUSTRATE REQUIRED COMPONENTS AS WELL AS MOUNTING AND SPACING DETAILS FOR THESE COMPONENTS. DIAGRAMS ALSO ILLUSTRATE THE PREFERRED LAYOUT FOR THESE COMPONENTS BASED ON STANDARD ROOM LAYOUTS. THE DIAGRAMS DO NOT NECESSARILY ILLUSTRATE THE QUANTITY REQUIRED OF EACH COMPONENT NOR THE ACTUAL LOCATION FOR THESE COMPONENTS. EXACT QUANTITY AND LOCATION WILL BE DETERMINED DURING THE DESIGN AND CONSTRUCTION PROCESSES.

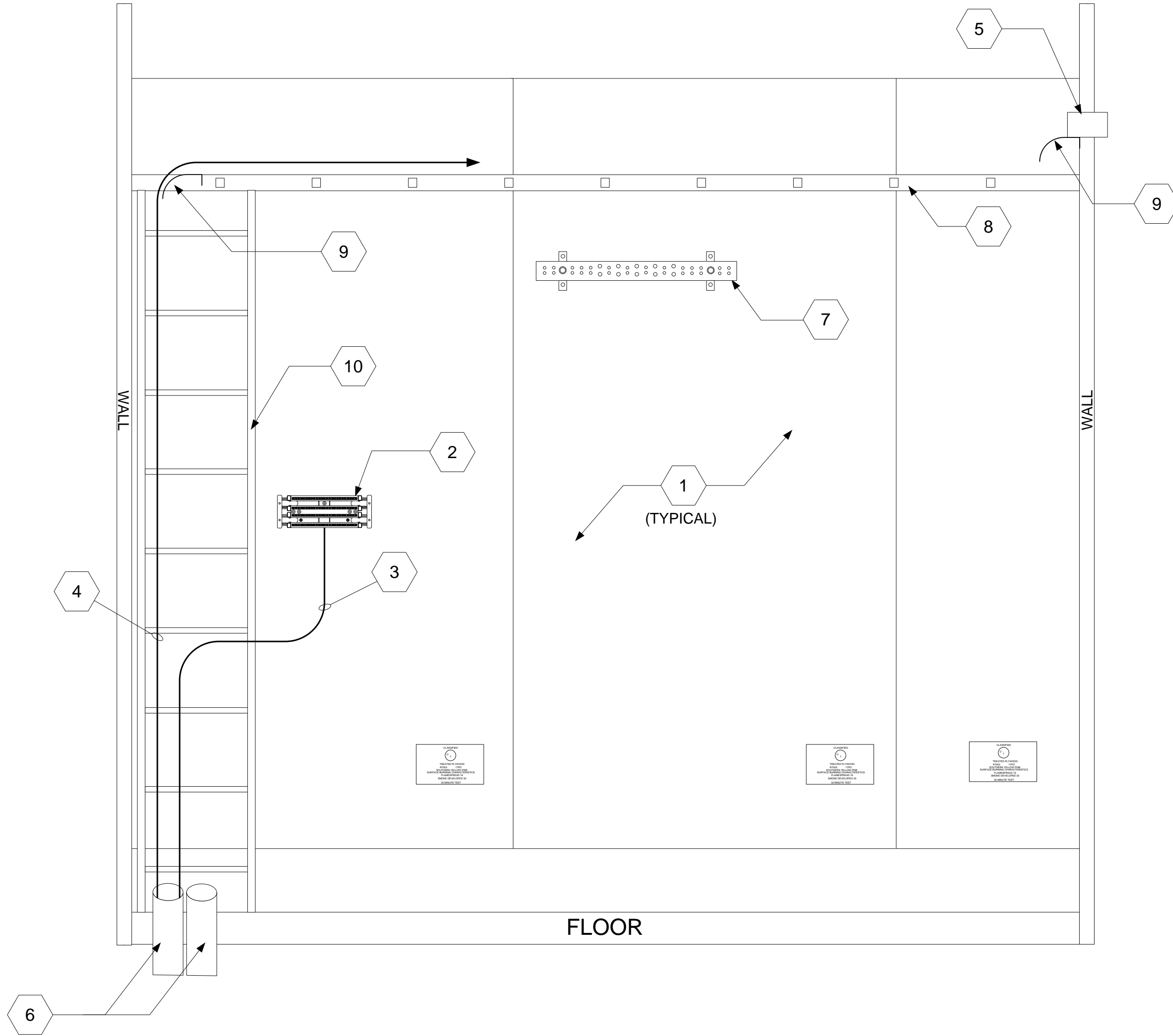

REVISIONS	DATE	APPR.

DESIGNED BY: JOHN BABB	DATE: JUNE 2016	FOR OFFICIAL USE ONLY
DESIGNED BY: DEREK MITCHELL		
REVIEWED BY: ROBERT BABB USARC G-6 RCDD		

USARC G-6
NETWORKING AND
INFRASTRUCTURE
BRANCH
INFRASTRUCTURE
TEAM

U.S. ARMY RESERVE
NETWORK ENTERPRISE CENTER
INFRASTRUCTURE
TECHNICAL CRITERIA
DIAGRAM AND DETAILS

B.12

TYPICAL SECOND FLOOR STANDARD TR WALL ELEVATION DIAGRAM

SHEET KEY NOTES

- 1 PLYWOOD SHALL BE INSTALLED SO THAT THE A GRADE SIDE FACES INTO THE ROOM. MOUNT AT 8 INCHES AFF. DO NOT PAINT. AT LEAST ONE FIRE RATED STAMP IS TO BE VISIBLE ON EACH SHEET OF PLYWOOD
- 2 110 BLOCK FOR 25 PAIR COPPER CABLE TO THE TER
- 3 NEMA 5-20 DUPLEX CONVENIENCE RECEPTACLE
- 4 EQUIPMENT RACK RECEPTACLE
- 5 TMGB/TGB
- 6 HORIZONTAL LADDER RACK
- 7 TELECOMMUNICATIONS EQUIPMENT RACK
- 8 VERTICAL WIRE MANAGERS
- 9 STANDARD WALL SLEEVES OR SELF-SEALING, RE-ENTERABLE, MECHANICAL FIRE-STOPPING WALL SLEEVES (AS REQUIRED PER TECHNICAL CRITERIA)

SHEET GENERAL NOTES

1. ALL DIAGRAMS ILLUSTRATE REQUIRED COMPONENTS AS WELL AS MOUNTING AND SPACING DETAILS FOR THESE COMPONENTS. DIAGRAMS ALSO ILLUSTRATE THE PREFERRED LAYOUT FOR THESE COMPONENTS BASED ON STANDARD ROOM LAYOUTS. THE DIAGRAMS DO NOT NECESSARILY ILLUSTRATE THE QUANTITY REQUIRED OF EACH COMPONENT NOR THE ACTUAL LOCATION FOR THESE COMPONENTS. EXACT QUANTITY AND LOCATION WILL BE DETERMINED DURING THE DESIGN AND CONSTRUCTION PROCESSES.



REVISIONS	DATE	APPR.

DESIGNED BY: JOHN BABB	DATE: JUNE 2016	FOR OFFICIAL USE ONLY
DESIGNED BY: DEREK MITCHELL		
REVIEWED BY: ROBERT BABB USARC G-6 RCDD		

**USARC G-6
NETWORKING AND
INFRASTRUCTURE
BRANCH
INFRASTRUCTURE
TEAM**

**U.S. ARMY RESERVE
NETWORK ENTERPRISE CENTER
INFRASTRUCTURE
TECHNICAL CRITERIA
DIAGRAM AND DETAILS**

B.13

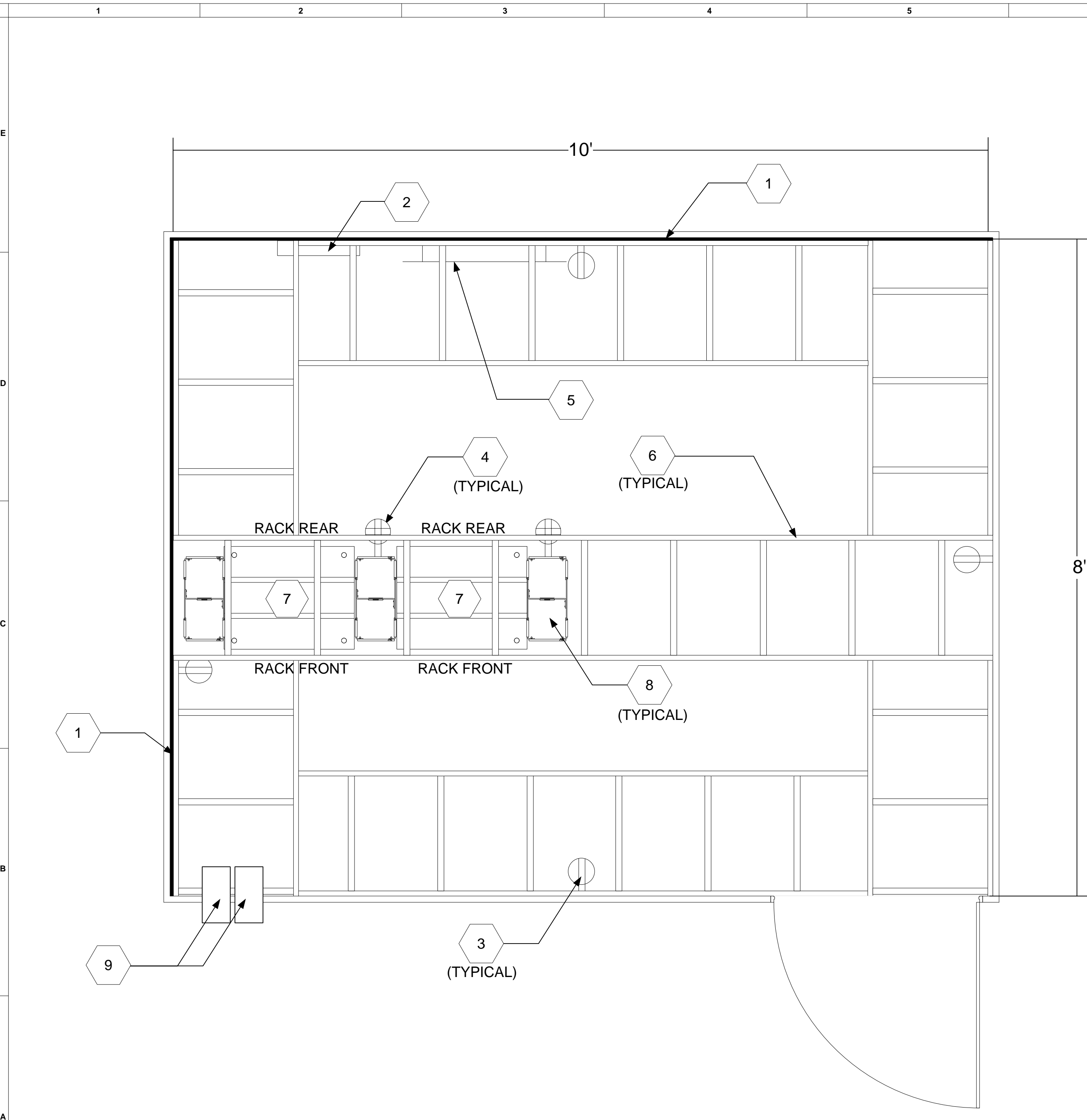

TYPICAL 1ST FLOOR STANDARD TR AERIAL DIAGRAM

SHEET KEY NOTES

- 1 PLYWOOD SHALL BE INSTALLED SO THAT THE A GRADE SIDE FACES INTO THE ROOM. MOUNT AT 8 INCHES AFF. DO NOT PAINT. AT LEAST ONE FIRE RATED STAMP IS TO BE VISIBLE ON EACH SHEET OF PLYWOOD
- 2 110 BLOCK FOR 25 PAIR COPPER CABLE TO THE TER
- 3 NEMA 5-20 DUPLEX CONVENIENCE RECEPTACLE
- 4 EQUIPMENT RACK RECEPTACLE
- 5 TMGB/TGB
- 6 HORIZONTAL LADDER RACK
- 7 TELECOMMUNICATIONS EQUIPMENT RACK
- 8 VERTICAL WIRE MANAGERS
- 9 STANDARD WALL SLEEVES OR SELF-SEALING, RE-ENTERABLE, MECHANICAL FIRE-STOPPING WALL SLEEVES (AS REQUIRED PER TECHNICAL CRITERIA)
- 10 SELF-SEALING, RE-ENTERABLE, MECHANICAL FIRE-STOPPING FLOOR SLEEVES

SHEET GENERAL NOTES

1. ALL DIAGRAMS ILLUSTRATE REQUIRED COMPONENTS AS WELL AS MOUNTING AND SPACING DETAILS FOR THESE COMPONENTS. DIAGRAMS ALSO ILLUSTRATE THE PREFERRED LAYOUT FOR THESE COMPONENTS BASED ON STANDARD ROOM LAYOUTS. THE DIAGRAMS DO NOT NECESSARILY ILLUSTRATE THE QUANTITY REQUIRED OF EACH COMPONENT NOR THE ACTUAL LOCATION FOR THESE COMPONENTS. EXACT QUANTITY AND LOCATION WILL BE DETERMINED DURING THE DESIGN AND CONSTRUCTION PROCESSES.



REVISIONS	DATE	APPR.

DESIGNED BY: JOHN BABB	DATE: JUNE 2016	FOR OFFICIAL USE ONLY
DESIGNED BY: DEREK MITCHELL		
REVIEWED BY: ROBERT BABB USARC G-6 RCDD		

USARC G-6
NETWORKING AND
INFRASTRUCTURE
BRANCH
INFRASTRUCTURE
TEAM

U.S. ARMY RESERVE
NETWORK ENTERPRISE CENTER
INFRASTRUCTURE
TECHNICAL CRITERIA
DIAGRAM AND DETAILS

B.14

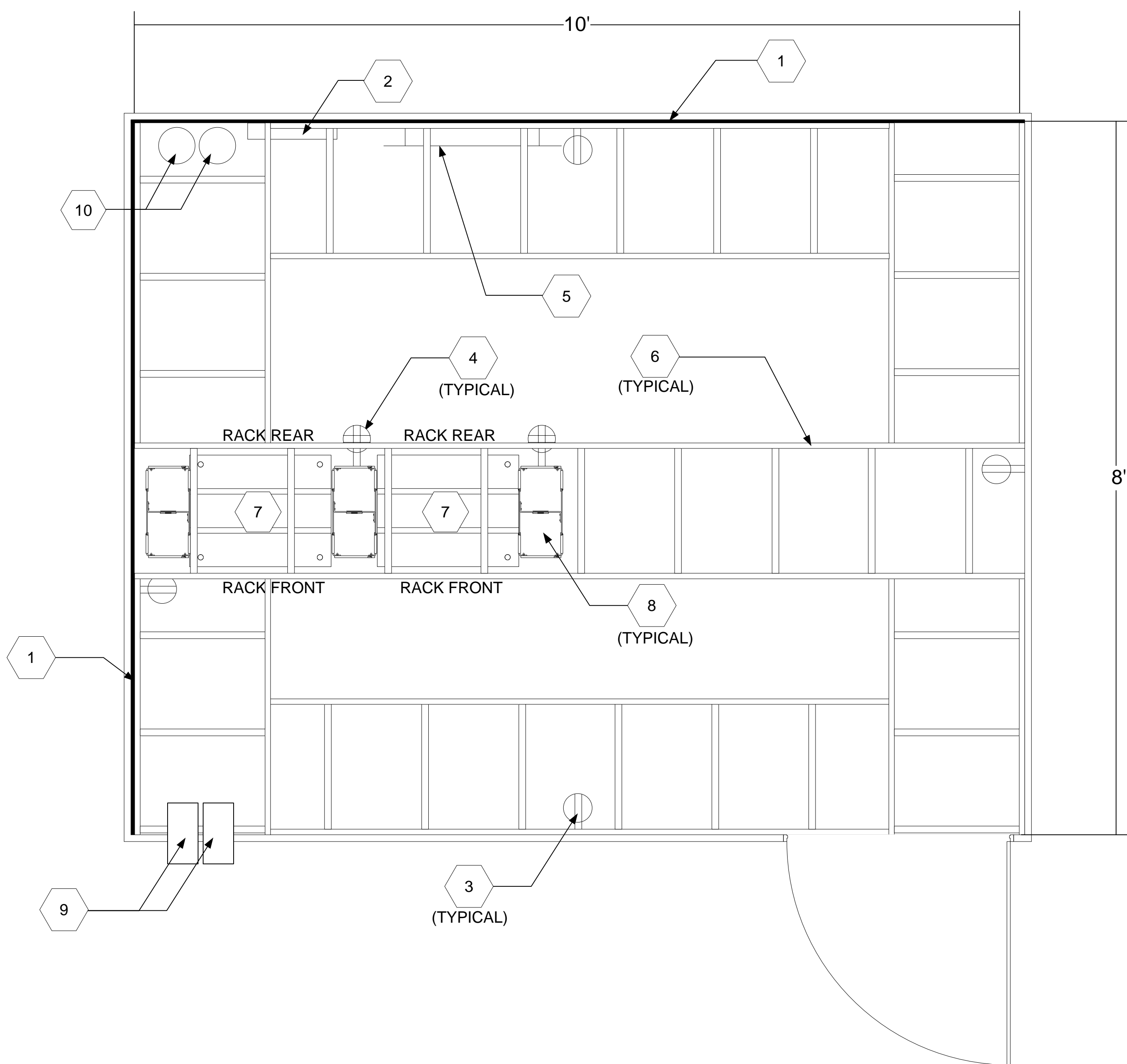

TYPICAL 2ND FLOOR STANDARD TR AERIAL DIAGRAM

SHEET GENERAL NOTES

1. ALL DIAGRAMS ILLUSTRATE REQUIRED COMPONENTS AS WELL AS MOUNTING AND SPACING DETAILS FOR THESE COMPONENTS. DIAGRAMS ALSO ILLUSTRATE THE PREFERRED LAYOUT FOR THESE COMPONENTS BASED ON STANDARD ROOM LAYOUTS. THE DIAGRAMS DO NOT NECESSARILY ILLUSTRATE THE QUANTITY REQUIRED OF EACH COMPONENT NOR THE ACTUAL LOCATION FOR THESE COMPONENTS. EXACT QUANTITY AND LOCATION WILL BE DETERMINED DURING THE DESIGN AND CONSTRUCTION PROCESSES.

SHEET KEY NOTES

- 1 2 POST EQUIPMENT RACK
- 2 2U HORIZONTAL WIRE MANAGER
- 3 2U FIBER PATCH PANEL
- 4 48 PORT PATCH PANEL
- 5 VERTICAL WIRE MANAGER
- 6 HORIZONTAL LADDER RACK
- 7 12 STRAND SM FOC TO THE TER

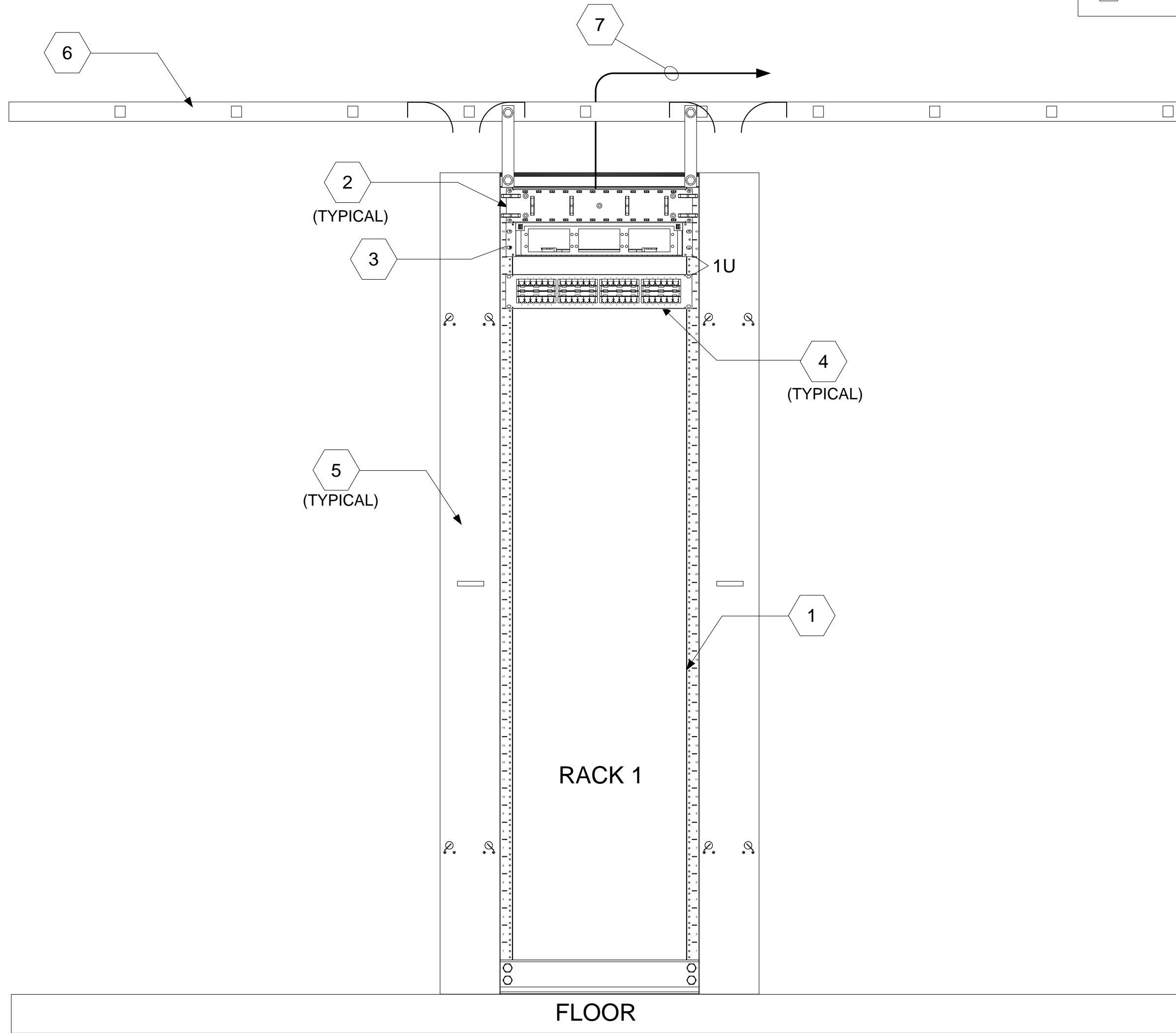

SYMBOL	REVISIONS DESCRIPTION	DATE	APPR.

DESIGNED BY: JOHN BABB	DATE: JUNE 2016
DESIGNED BY: DEREK MITCHELL	FOR OFFICIAL USE ONLY
REVIEWED BY: ROBERT BABB	
USARC G-6 RCDD	

USARC G-6
NETWORKING AND
INFRASTRUCTURE
BRANCH
INFRASTRUCTURE
TEAM

U.S. ARMY RESERVE
NETWORK ENTERPRISE CENTER
INFRASTRUCTURE
TECHNICAL CRITERIA
DIAGRAM AND DETAILS

B.15

TYPICAL SMALL TR RACK ELEVATION FRONT VIEW DIAGRAM

SHEET GENERAL NOTES

1. ALL DIAGRAMS ILLUSTRATE REQUIRED COMPONENTS AS WELL AS MOUNTING AND SPACING DETAILS FOR THESE COMPONENTS. DIAGRAMS ALSO ILLUSTRATE THE PREFERRED LAYOUT FOR THESE COMPONENTS BASED ON STANDARD ROOM LAYOUTS. THE DIAGRAMS DO NOT NECESSARILY ILLUSTRATE THE QUANTITY REQUIRED OF EACH COMPONENT NOR THE ACTUAL LOCATION FOR THESE COMPONENTS. EXACT QUANTITY AND LOCATION WILL BE DETERMINED DURING THE DESIGN AND CONSTRUCTION PROCESSES.

SHEET KEY NOTES

- 1 DOUBLE DUPLEX NEMA 5-20R RECEPTACLE
- 2 RACK MOUNTED BUS-BAR (RGB)
- 3 HORIZONTAL LADDER RACK



SYMBOL	REVISIONS DESCRIPTION	DATE	APPR.

DESIGNED BY: JOHN BABB	DATE: JUNE 2016
DESIGNED BY: DEREK MITCHELL	FOR OFFICIAL USE ONLY
REVIEWED BY: ROBERT BABB	
USARC G-6 RCDD	

USARC G-6
NETWORKING AND
INFRASTRUCTURE
BRANCH
INFRASTRUCTURE
TEAM

U.S. ARMY RESERVE
NETWORK ENTERPRISE CENTER
INFRASTRUCTURE
TECHNICAL CRITERIA
DIAGRAM AND DETAILS

B.16

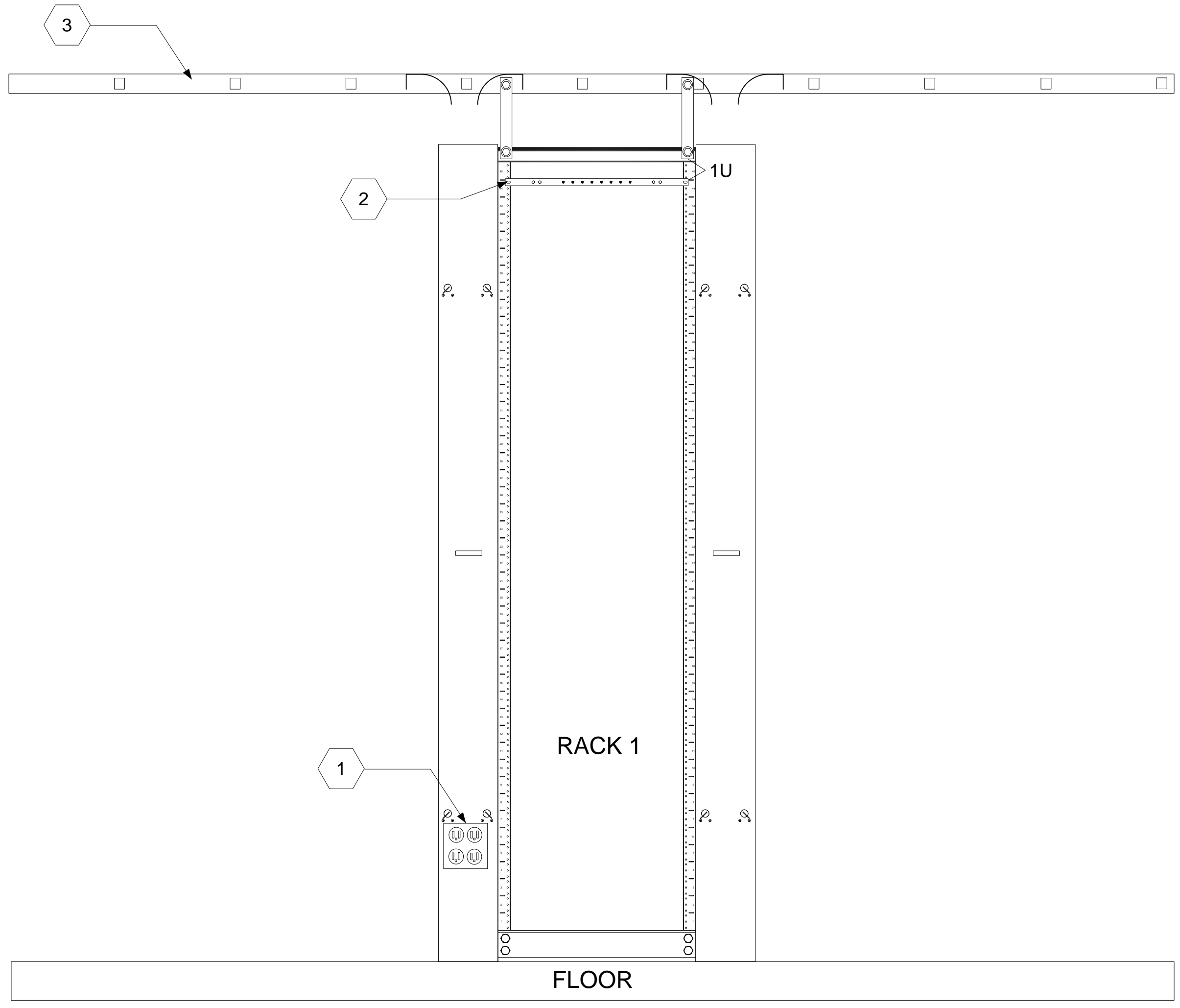

TYPICAL SMALL TR RACK ELEVATION REAR VIEW DIAGRAM

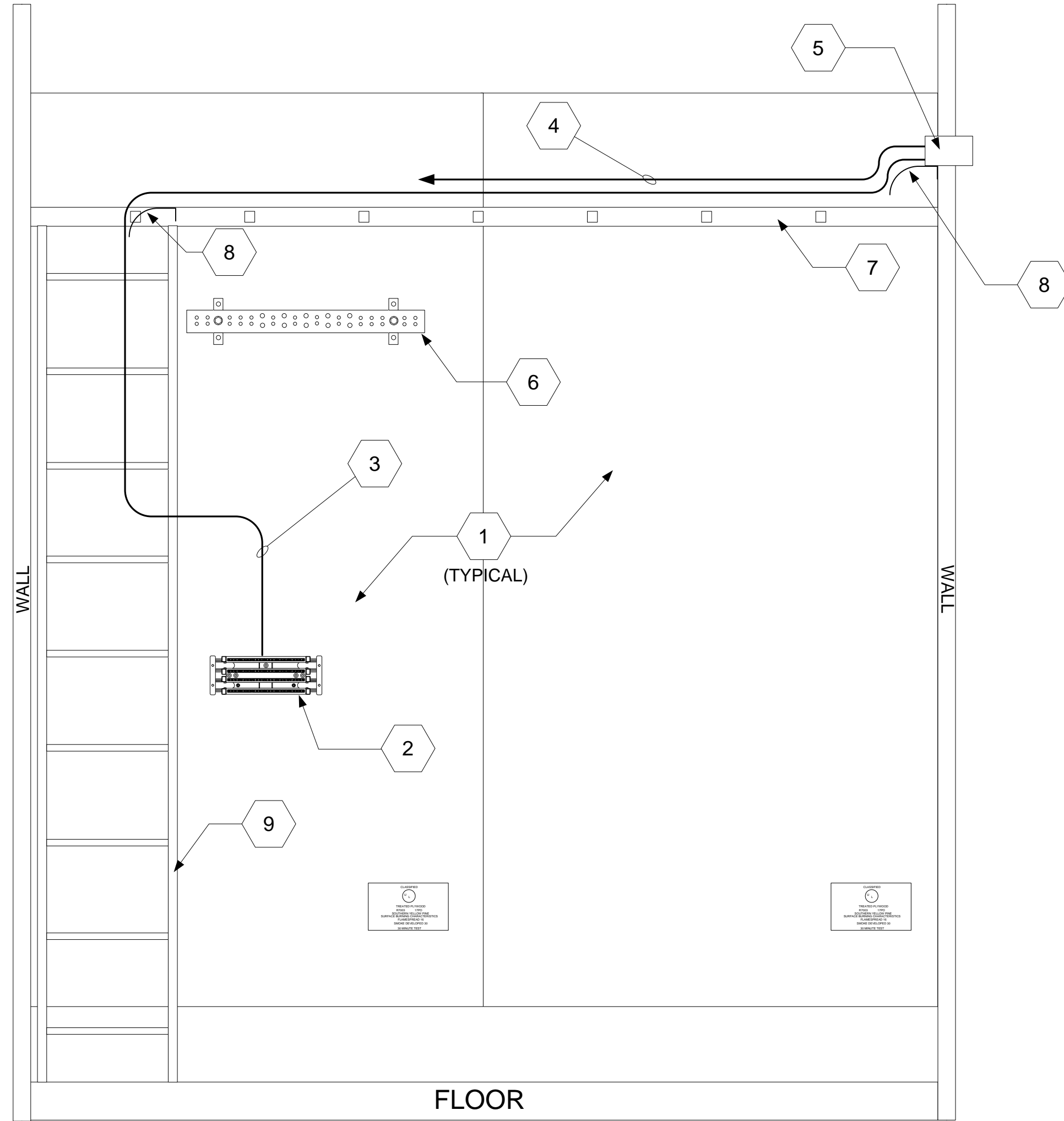

SHEET KEY NOTES

- 1 PLYWOOD SHALL BE INSTALLED SO THAT THE A GRADE SIDE FACES INTO THE ROOM. MOUNT AT 8 INCHES AFF. DO NOT PAINT. AT LEAST ONE FIRE RATED STAMP IS TO BE VISIBLE ON EACH SHEET OF PLYWOOD
- 2 110 BLOCK FOR COPPER BACKBONE CABLE TO TER
- 3 COPPER BACKBONE CABLE TO TER
- 4 FIBER OPTIC BACKBONE CABLE TO TER
- 5 STANDARD WALL SLEEVES OR SELF-SEALING, RE-ENTERABLE, MECHANICAL FIRE-STOPPING WALL SLEEVES (AS REQUIRED PER TECHNICAL CRITERIA)
- 6 TMGB/TGB
- 7 HORIZONTAL LADDER RACK
- 8 CABLE RADIUS DROP OUTS (WATERFALL SUPPORTS)
- 9 VERTICAL LADDER RACK

SHEET GENERAL NOTES

1. ALL DIAGRAMS ILLUSTRATE REQUIRED COMPONENTS AS WELL AS MOUNTING AND SPACING DETAILS FOR THESE COMPONENTS. DIAGRAMS ALSO ILLUSTRATE THE PREFERRED LAYOUT FOR THESE COMPONENTS BASED ON STANDARD ROOM LAYOUTS. THE DIAGRAMS DO NOT NECESSARILY ILLUSTRATE THE QUANTITY REQUIRED OF EACH COMPONENT NOR THE ACTUAL LOCATION FOR THESE COMPONENTS. EXACT QUANTITY AND LOCATION WILL BE DETERMINED DURING THE DESIGN AND CONSTRUCTION PROCESSES.



REVISIONS	DATE	APPR.

DESIGNED BY: JOHN BABB	DATE: JUNE 2016	FOR OFFICIAL USE ONLY
DESIGNED BY: DEREK MITCHELL		
REVIEWED BY: ROBERT BABB		
USARC G-6	USARC G-6 RCDD	

USARC G-6
NETWORKING AND
INFRASTRUCTURE
BRANCH
INFRASTRUCTURE
TEAM

U.S. ARMY RESERVE
NETWORK ENTERPRISE CENTER
INFRASTRUCTURE
TECHNICAL CRITERIA
DIAGRAM AND DETAILS

B.17

TYPICAL FIRST FLOOR SMALL TR WALL ELEVATION DIAGRAM

SHEET KEY NOTES

- 1 PLYWOOD SHALL BE INSTALLED SO THAT THE A GRADE SIDE FACES INTO THE ROOM. MOUNT AT 8 INCHES AFF. DO NOT PAINT. AT LEAST ONE FIRE RATED STAMP IS TO BE VISIBLE ON EACH SHEET OF PLYWOOD
- 2 110 BLOCK FOR COPPER BACKBONE CABLE TO TER
- 3 COPPER BACKBONE CABLE TO TER
- 4 FIBER OPTIC BACKBONE CABLE TO TER
- 5 STANDARD WALL SLEEVES OR SELF-SEALING, RE-ENTERABLE, MECHANICAL FIRE-STOPPING WALL SLEEVES (AS REQUIRED PER TECHNICAL CRITERIA)
- 6 SELF-SEALING, RE-ENTERABLE, MECHANICAL FIRE-STOPPING FLOOR SLEEVES
- 7 TMGB/TGB
- 8 HORIZONTAL LADDER RACK
- 9 CABLE RADIUS DROP OUTS (WATERFALL SUPPORTS)
- 10 VERTICAL LADDER RACK

SHEET GENERAL NOTES

1. ALL DIAGRAMS ILLUSTRATE REQUIRED COMPONENTS AS WELL AS MOUNTING AND SPACING DETAILS FOR THESE COMPONENTS. DIAGRAMS ALSO ILLUSTRATE THE PREFERRED LAYOUT FOR THESE COMPONENTS BASED ON STANDARD ROOM LAYOUTS. THE DIAGRAMS DO NOT NECESSARILY ILLUSTRATE THE QUANTITY REQUIRED OF EACH COMPONENT NOR THE ACTUAL LOCATION FOR THESE COMPONENTS. EXACT QUANTITY AND LOCATION WILL BE DETERMINED DURING THE DESIGN AND CONSTRUCTION PROCESSES.



REVISIONS	DATE	APPR.
SYMBOL		

DESIGNED BY:	DATE:	FOR
JOHN BABB	JUNE 2016	OFFICIAL USE ONLY
DESIGNED BY:		
DEREK MITCHELL		
REVIEWED BY:		
ROBERT BABB		
USARC G-6 RCDD		

USARC G-6
NETWORKING AND
INFRASTRUCTURE
BRANCH
INFRASTRUCTURE
TEAM

U.S. ARMY RESERVE
NETWORK ENTERPRISE CENTER
INFRASTRUCTURE
TECHNICAL CRITERIA
DIAGRAM AND DETAILS

B.18

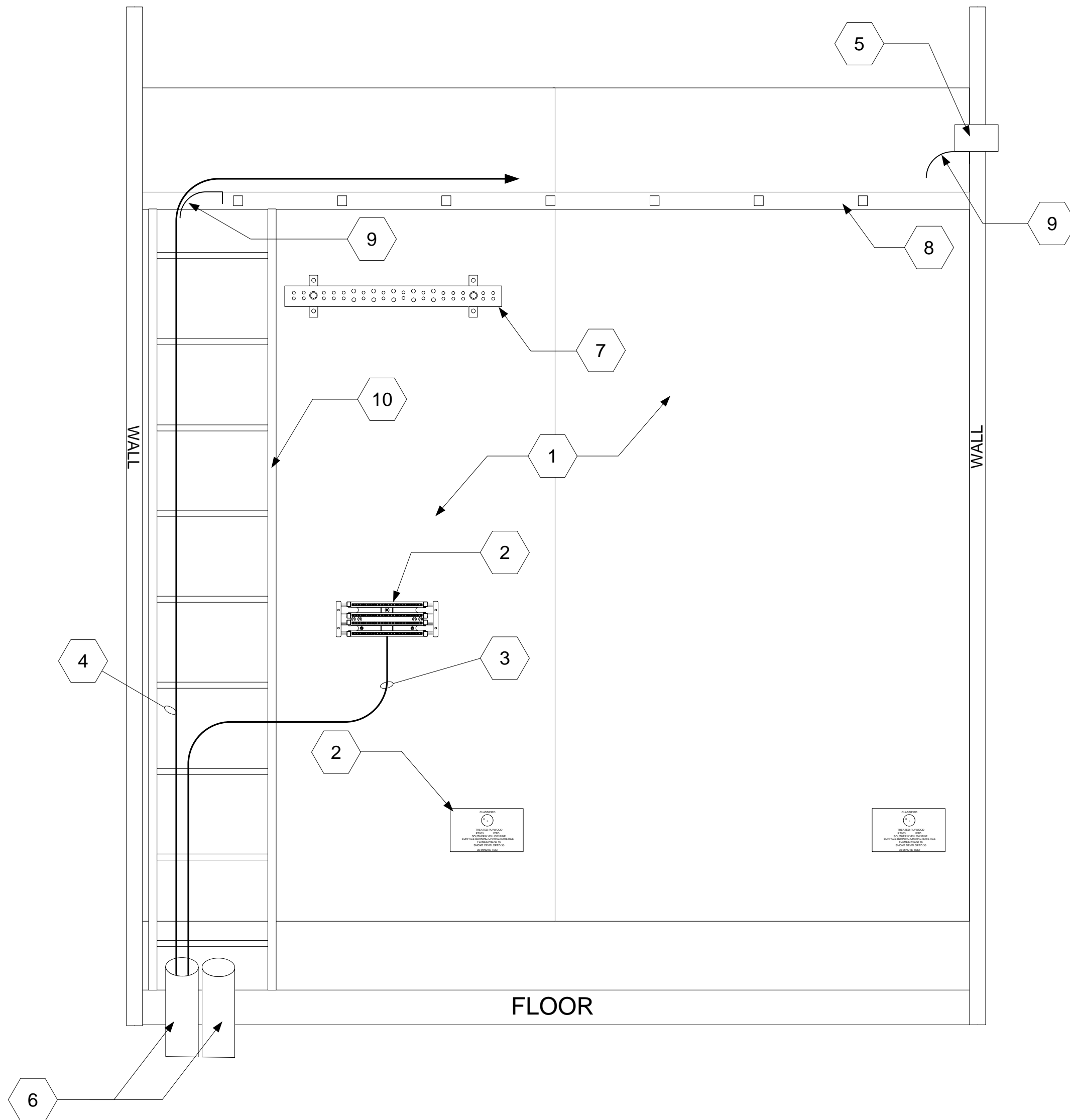

TYPICAL SECOND FLOOR SMALL TR WALL ELEVATION DIAGRAM

SHEET KEY NOTES

- 1 PLYWOOD SHALL BE INSTALLED SO THAT THE A GRADE SIDE FACES INTO THE ROOM. MOUNT AT 8 INCHES AFF. DO NOT PAINT. AT LEAST ONE FIRE RATED STAMP IS TO BE VISIBLE ON EACH SHEET OF PLYWOOD
- 2 110 BLOCK FOR 25 PAIR COPPER CABLE TO THE TER
- 3 NEMA 5-20 DUPLEX CONVENIENCE RECEPTACLE
- 4 EQUIPMENT RACK RECEPTACLE
- 5 TMGB/TGB
- 6 HORIZONTAL LADDER RACK
- 7 TELECOMMUNICATIONS EQUIPMENT RACK
- 8 VERTICAL WIRE MANAGERS
- 9 STANDARD WALL SLEEVES OR SELF-SEALING, RE-ENTERABLE, MECHANICAL FIRE-STOPPING WALL SLEEVES (AS REQUIRED PER TECHNICAL CRITERIA)

SHEET GENERAL NOTES

1. ALL DIAGRAMS ILLUSTRATE REQUIRED COMPONENTS AS WELL AS MOUNTING AND SPACING DETAILS FOR THESE COMPONENTS. DIAGRAMS ALSO ILLUSTRATE THE PREFERRED LAYOUT FOR THESE COMPONENTS BASED ON STANDARD ROOM LAYOUTS. THE DIAGRAMS DO NOT NECESSARILY ILLUSTRATE THE QUANTITY REQUIRED OF EACH COMPONENT NOR THE ACTUAL LOCATION FOR THESE COMPONENTS. EXACT QUANTITY AND LOCATION WILL BE DETERMINED DURING THE DESIGN AND CONSTRUCTION PROCESSES.



REVISIONS	DATE	APPR.

DESIGNED BY: JOHN BABB	DATE: JUNE 2016	FOR OFFICIAL USE ONLY
DESIGNED BY: DEREK MITCHELL		
REVIEWED BY: ROBERT BABB USARC G-6 RCDD		

**USARC G-6
NETWORKING AND
INFRASTRUCTURE
BRANCH
INFRASTRUCTURE
TEAM**

**U.S. ARMY RESERVE
NETWORK ENTERPRISE CENTER
INFRASTRUCTURE
TECHNICAL CRITERIA
DIAGRAM AND DETAILS**

B.19

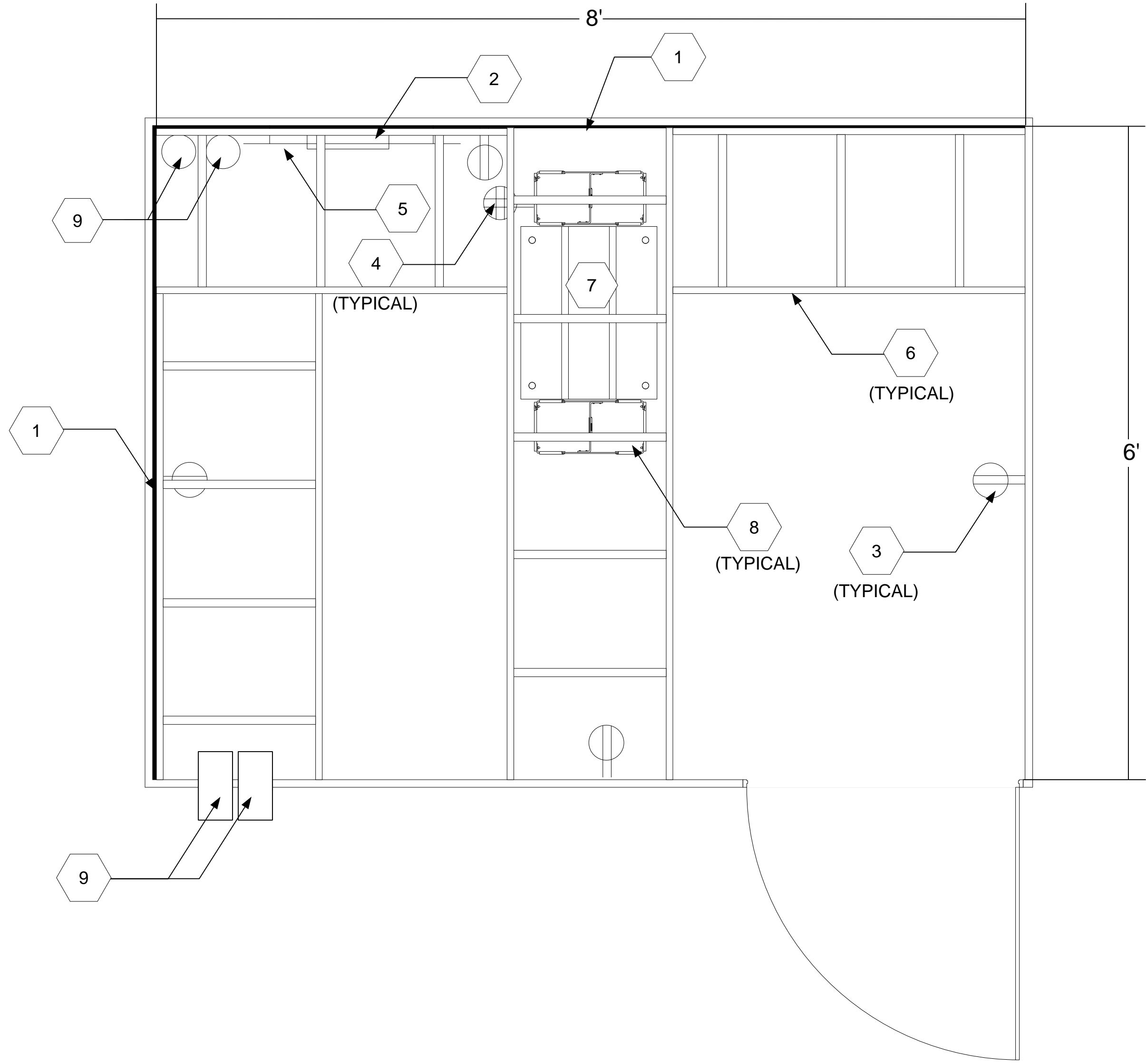

TYPICAL 1ST FLOOR SMALL TR AERIAL DIAGRAM

SHEET KEY NOTES

- 1 PLYWOOD SHALL BE INSTALLED SO THAT THE A GRADE SIDE FACES INTO THE ROOM. MOUNT AT 8 INCHES AFF. DO NOT PAINT. AT LEAST ONE FIRE RATED STAMP IS TO BE VISIBLE ON EACH SHEET OF PLYWOOD
- 2 110 BLOCK FOR 25 PAIR COPPER CABLE TO THE TER
- 3 NEMA 5-20 DUPLEX CONVENIENCE RECEPTACLE
- 4 EQUIPMENT RACK RECEPTACLE
- 5 TMGB/TGB
- 6 HORIZONTAL LADDER RACK
- 7 TELECOMMUNICATIONS EQUIPMENT RACK
- 8 VERTICAL WIRE MANAGERS
- 9 STANDARD WALL SLEEVES OR SELF-SEALING, RE-ENTERABLE, MECHANICAL FIRE-STOPPING WALL SLEEVES (AS REQUIRED PER TECHNICAL CRITERIA)

SHEET GENERAL NOTES

1. ALL DIAGRAMS ILLUSTRATE REQUIRED COMPONENTS AS WELL AS MOUNTING AND SPACING DETAILS FOR THESE COMPONENTS. DIAGRAMS ALSO ILLUSTRATE THE PREFERRED LAYOUT FOR THESE COMPONENTS BASED ON STANDARD ROOM LAYOUTS. THE DIAGRAMS DO NOT NECESSARILY ILLUSTRATE THE QUANTITY REQUIRED OF EACH COMPONENT NOR THE ACTUAL LOCATION FOR THESE COMPONENTS. EXACT QUANTITY AND LOCATION WILL BE DETERMINED DURING THE DESIGN AND CONSTRUCTION PROCESSES.



REVISIONS	DATE	APPR.

DESIGNED BY: JOHN BABB	DATE: JUNE 2016	FOR OFFICIAL USE ONLY
DESIGNED BY: DEREK MITCHELL		
REVIEWED BY: ROBERT BABB USARC G-6 RCDD		

**USARC G-6
NETWORKING AND
INFRASTRUCTURE
BRANCH
INFRASTRUCTURE
TEAM**

**U.S. ARMY RESERVE
NETWORK ENTERPRISE CENTER
INFRASTRUCTURE
TECHNICAL CRITERIA
DIAGRAM AND DETAILS**

B.20

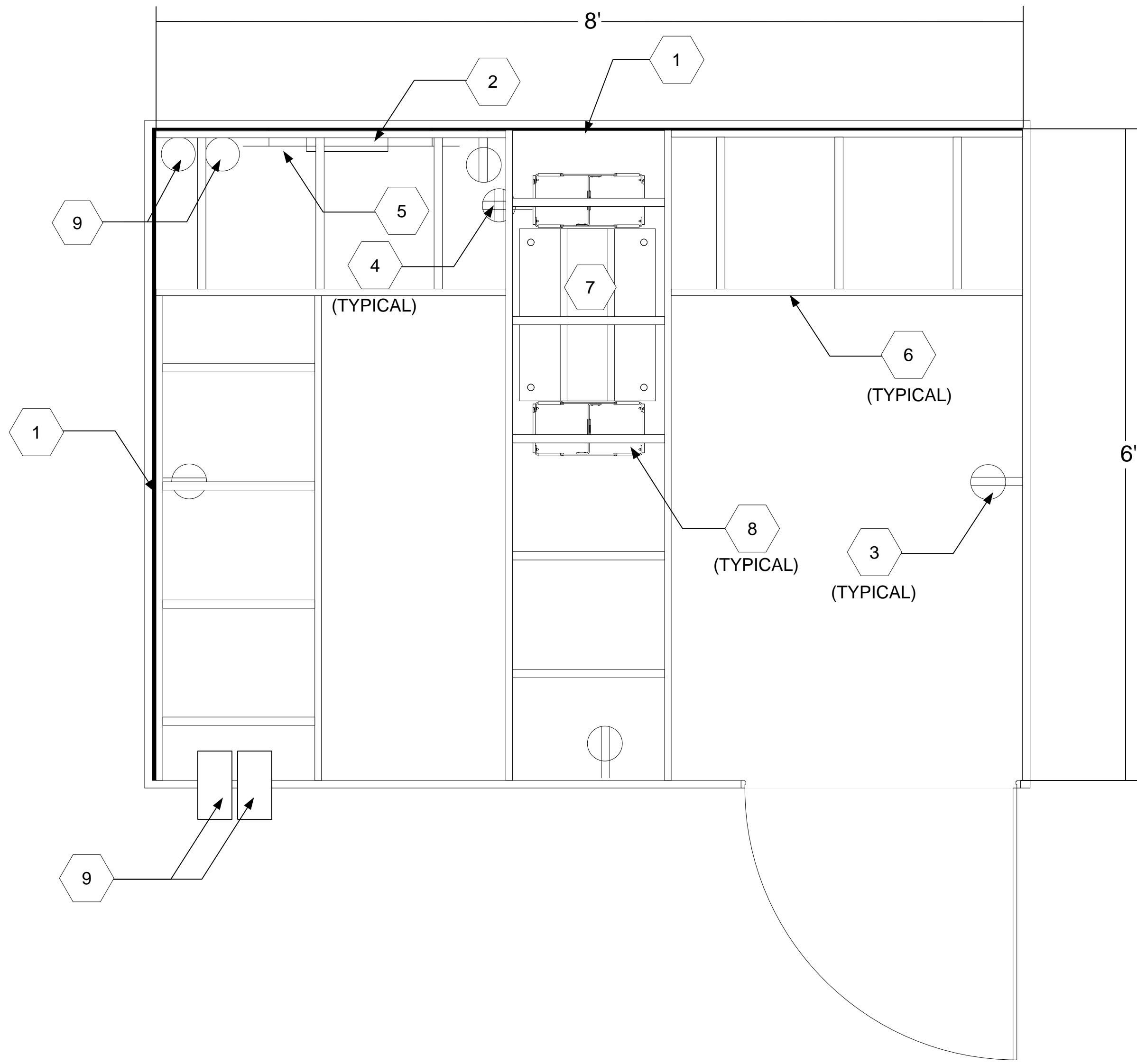

TYPICAL 2ND FLOOR SMALL TR AERIAL DIAGRAM

SHEET GENERAL NOTES

1. ALL DIAGRAMS ILLUSTRATE REQUIRED COMPONENTS AS WELL AS MOUNTING AND SPACING DETAILS FOR THESE COMPONENTS. DIAGRAMS ALSO ILLUSTRATE THE PREFERRED LAYOUT FOR THESE COMPONENTS BASED ON STANDARD ROOM LAYOUTS. THE DIAGRAMS DO NOT NECESSARILY ILLUSTRATE THE QUANTITY REQUIRED OF EACH COMPONENT NOR THE ACTUAL LOCATION FOR THESE COMPONENTS. EXACT QUANTITY AND LOCATION WILL BE DETERMINED DURING THE DESIGN AND CONSTRUCTION PROCESSES.

SHEET KEY NOTES

- 1 2 POST EQUIPMENT RACK
- 2 2U HORIZONTAL WIRE MANAGER
- 3 2U FIBER PATCH PANEL
- 4 48 PORT PATCH PANEL
- 5 VERTICAL WIRE MANAGER
- 6 HORIZONTAL LADDER RACK
- 7 12 STRAND SM FOC TO THE TER

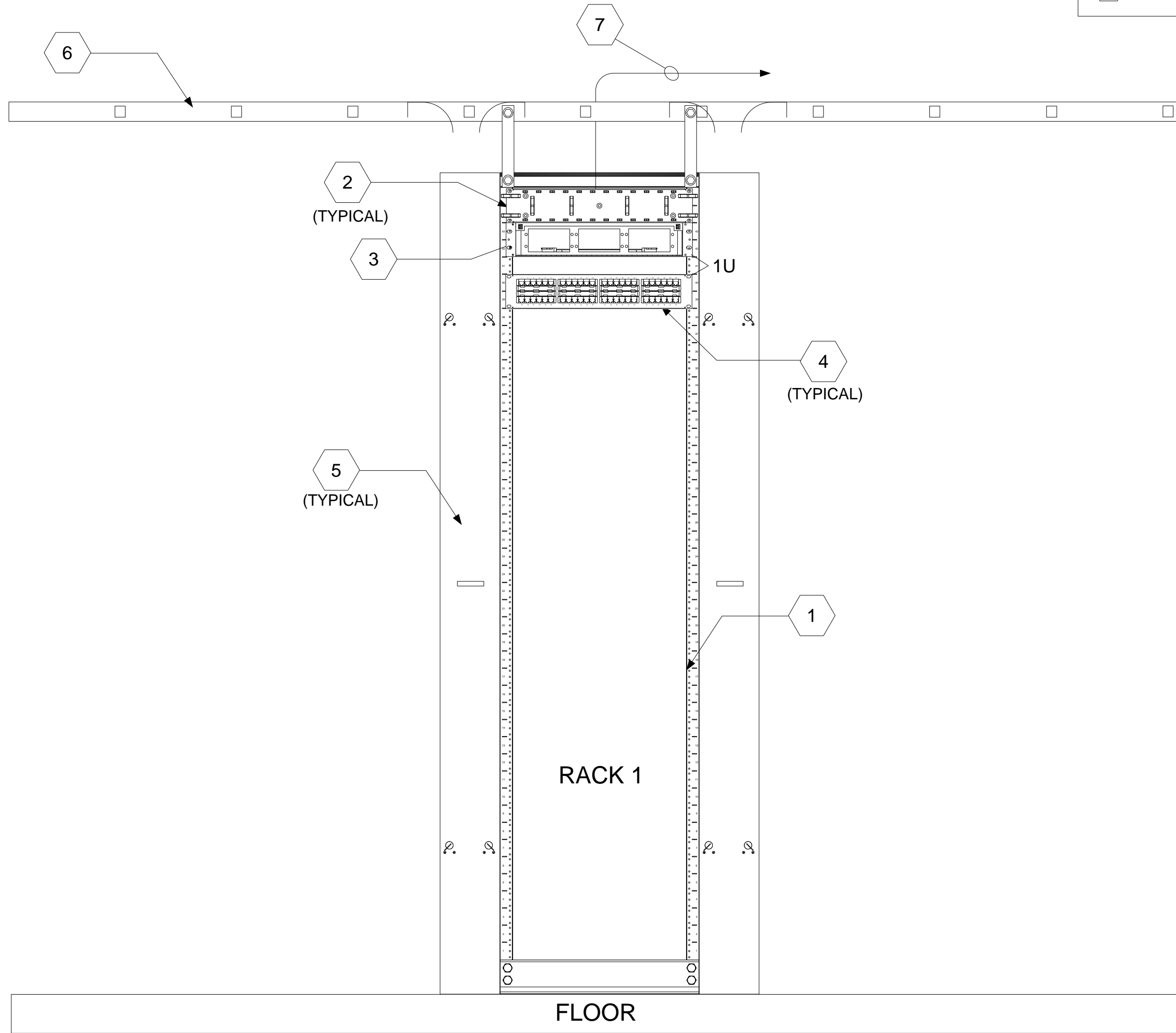

SYMBOL	REVISIONS DESCRIPTION	DATE	APPR.

DESIGNED BY: JOHN BABB	DATE: JUNE 2016
DESIGNED BY: DEREK MITCHELL	FOR OFFICIAL USE ONLY
REVIEWED BY: ROBERT BABB	
USARC G-6 RCDD	

USARC G-6
NETWORKING AND
INFRASTRUCTURE
BRANCH
INFRASTRUCTURE
TEAM

U.S. ARMY RESERVE
NETWORK ENTERPRISE CENTER
INFRASTRUCTURE
TECHNICAL CRITERIA
DIAGRAM AND DETAILS

B.21

TYPICAL OMS TR RACK FRONT ELEVATION DIAGRAM

SHEET GENERAL NOTES

1. ALL DIAGRAMS ILLUSTRATE REQUIRED COMPONENTS AS WELL AS MOUNTING AND SPACING DETAILS FOR THESE COMPONENTS. DIAGRAMS ALSO ILLUSTRATE THE PREFERRED LAYOUT FOR THESE COMPONENTS BASED ON STANDARD ROOM LAYOUTS. THE DIAGRAMS DO NOT NECESSARILY ILLUSTRATE THE QUANTITY REQUIRED OF EACH COMPONENT NOR THE ACTUAL LOCATION FOR THESE COMPONENTS. EXACT QUANTITY AND LOCATION WILL BE DETERMINED DURING THE DESIGN AND CONSTRUCTION PROCESSES.

SHEET KEY NOTES

- 1 DOUBLE DUPLEX NEMA 5-20R RECEPTACLE
- 2 RACK MOUNTED BUS-BAR (RGB)
- 3 HORIZONTAL LADDER RACK



SYMBOL	REVISIONS DESCRIPTION	DATE	APPR.

DESIGNED BY: JOHN BABB	DATE: JUNE 2016
DESIGNED BY: DEREK MITCHELL	FOR OFFICIAL USE ONLY
REVIEWED BY: ROBERT BABB	
USARC G-6 RCDD	

USARC G-6
NETWORKING AND
INFRASTRUCTURE
BRANCH
INFRASTRUCTURE
TEAM

U.S. ARMY RESERVE
NETWORK ENTERPRISE CENTER
INFRASTRUCTURE
TECHNICAL CRITERIA
DIAGRAM AND DETAILS

B.22

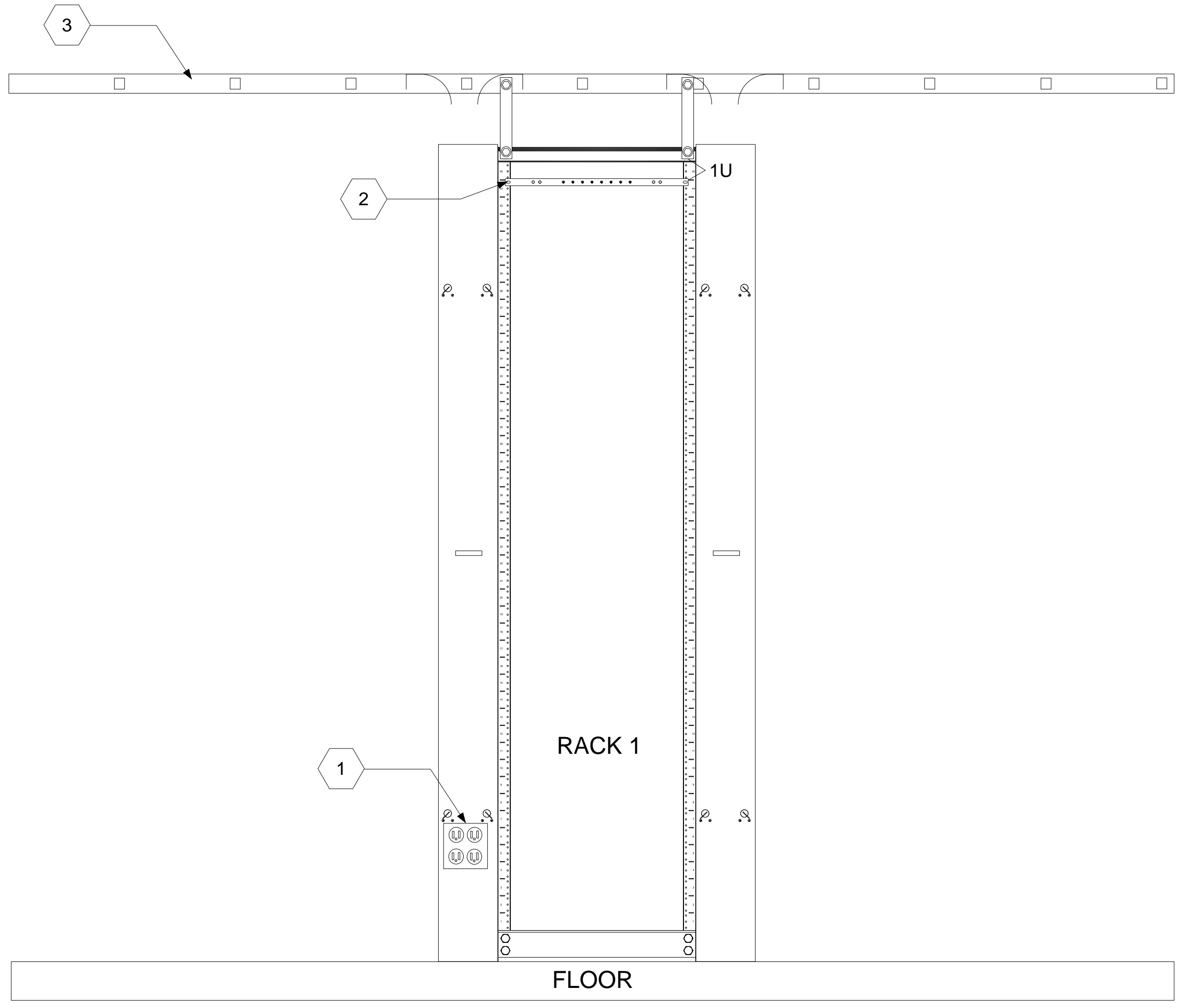

TYPICAL OMS TR RACK REAR ELEVATION DIAGRAM

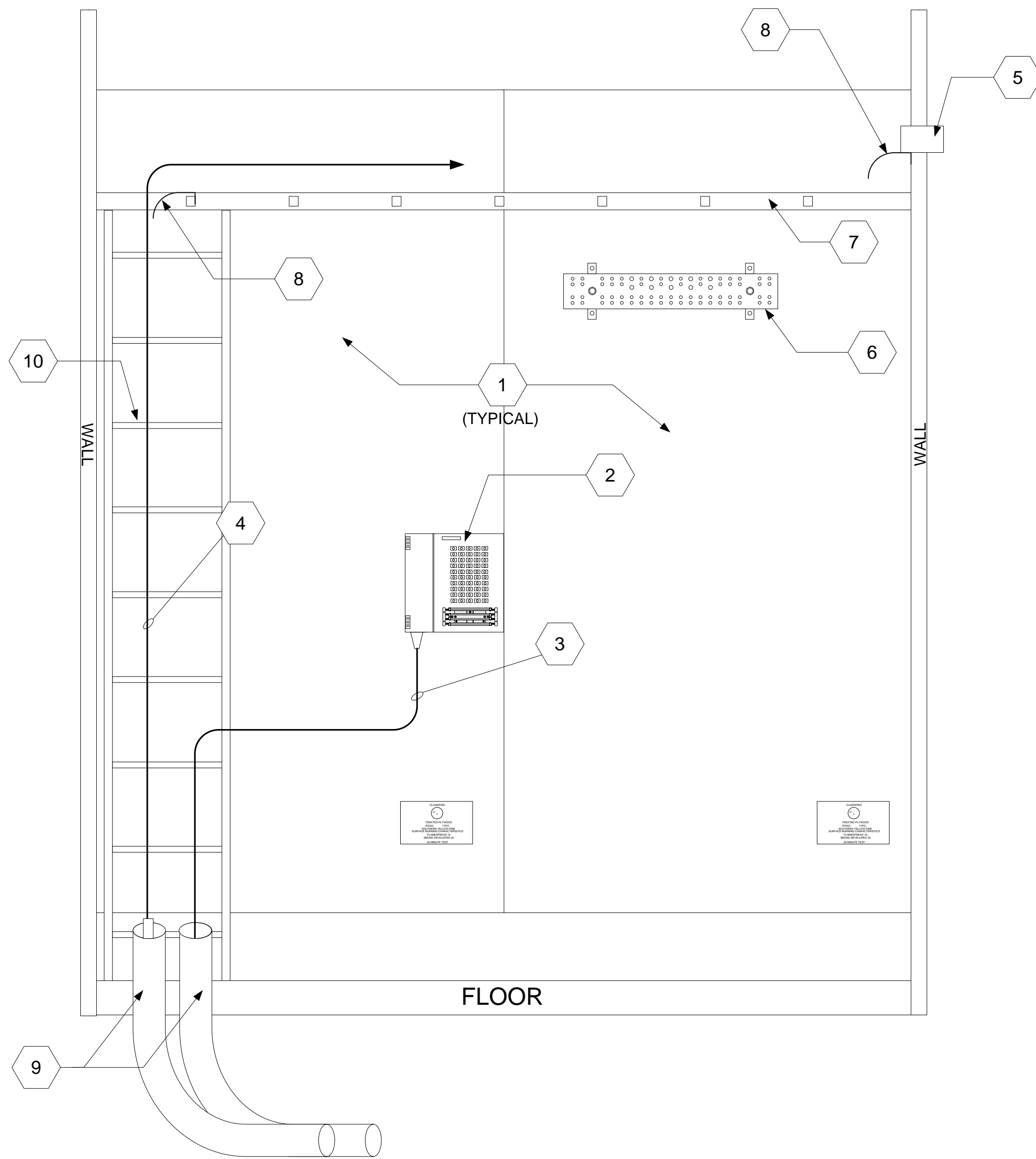

SHEET KEY NOTES

- 1 PLYWOOD SHALL BE INSTALLED SO THAT THE A GRADE SIDE FACES INTO THE ROOM. MOUNT AT 8 INCHES AFF. DO NOT PAINT. AT LEAST ONE FIRE RATED STAMP IS TO BE VISIBLE ON EACH SHEET OF PLYWOOD
- 2 BUILDING ENTRANCE PROTECTOR FOR BACKBONE COPPER TO TRAINING BUILDING TER
- 3 COPPER BACKBONE CABLE FROM TRAINING BUILDING TER
- 4 FIBER OPTIC BACKBONE CABLE FROM TRAINING BUILDING TER
- 5 STANDARD WALL SLEEVES OR SELF-SEALING, RE-ENTERABLE, MECHANICAL FIRE-STOPPING WALL SLEEVES (AS REQUIRED PER TECHNICAL CRITERIA)
- 6 TMGB/TGB
- 7 HORIZONTAL LADDER RACK
- 8 CABLE RADIUS DROP OUTS (WATERFALL SUPPORTS)
- 9 CONDUITS TO TRAINING BUILDING TER
- 10 VERTICAL LADDER RACK

SHEET GENERAL NOTES

1. ALL DIAGRAMS ILLUSTRATE REQUIRED COMPONENTS AS WELL AS MOUNTING AND SPACING DETAILS FOR THESE COMPONENTS. DIAGRAMS ALSO ILLUSTRATE THE PREFERRED LAYOUT FOR THESE COMPONENTS BASED ON STANDARD ROOM LAYOUTS. THE DIAGRAMS DO NOT NECESSARILY ILLUSTRATE THE QUANTITY REQUIRED OF EACH COMPONENT NOR THE ACTUAL LOCATION FOR THESE COMPONENTS. EXACT QUANTITY AND LOCATION WILL BE DETERMINED DURING THE DESIGN AND CONSTRUCTION PROCESSES.



REVISIONS	DATE	APPR.
SYMBOL		
DESCRIPTION		

DESIGNED BY: JOHN BABB	DATE: JUNE 2016	FOR OFFICIAL USE ONLY
DESIGNED BY: DEREK MITCHELL		
REVIEWED BY: ROBERT BABB		
USARC G-6 RCDD		

USARC G-6
NETWORKING AND
INFRASTRUCTURE
BRANCH
INFRASTRUCTURE
TEAM

U.S. ARMY RESERVE
NETWORK ENTERPRISE CENTER
INFRASTRUCTURE
TECHNICAL CRITERIA
DIAGRAM AND DETAILS

B.23

TYPICAL OMS TR WALL ELEVATION DIAGRAM

SHEET KEY NOTES

- 1 PLYWOOD SHALL BE INSTALLED SO THAT THE A GRADE SIDE FACES INTO THE ROOM. MOUNT AT 8 INCHES AFF. DO NOT PAINT. AT LEAST ONE FIRE RATED STAMP IS TO BE VISIBLE ON EACH SHEET OF PLYWOOD
- 2 BUILDING ENTRANCE PROTECTOR FOR BACKBONE COPPER TO TRAINING BUILDING TER
- 3 NEMA 5-20 DUPLEX CONVENIENCE RECEPTACLE
- 4 TMGB/TGB
- 5 HORIZONTAL LADDER RACK
- 6 CONDUITS TO OMS TR
- 7 TELECOMMUNICATIONS EQUIPMENT RACK
- 8 VERTICAL WIRE MANAGERS
- 9 EQUIPMENT RACK RECEPTACLE
- 10 STANDARD WALL SLEEVES OR SELF-SEALING, RE-ENTERABLE, MECHANICAL FIRE-STOPPING WALL SLEEVES (AS REQUIRED PER TECHNICAL CRITERIA)

SHEET GENERAL NOTES

1. ALL DIAGRAMS ILLUSTRATE REQUIRED COMPONENTS AS WELL AS MOUNTING AND SPACING DETAILS FOR THESE COMPONENTS. DIAGRAMS ALSO ILLUSTRATE THE PREFERRED LAYOUT FOR THESE COMPONENTS BASED ON STANDARD ROOM LAYOUTS. THE DIAGRAMS DO NOT NECESSARILY ILLUSTRATE THE QUANTITY REQUIRED OF EACH COMPONENT NOR THE ACTUAL LOCATION FOR THESE COMPONENTS. EXACT QUANTITY AND LOCATION WILL BE DETERMINED DURING THE DESIGN AND CONSTRUCTION PROCESSES.



REVISIONS	DATE	APPR.

DESIGNED BY: JOHN BABB	DATE: JUNE 2016	FOR OFFICIAL USE ONLY
DESIGNED BY: DEREK MITCHELL		
REVIEWED BY: ROBERT BABB		
USARC G-6 RCDD		

**USARC G-6
NETWORKING AND
INFRASTRUCTURE
BRANCH
INFRASTRUCTURE
TEAM**

**U.S. ARMY RESERVE
NETWORK ENTERPRISE CENTER
INFRASTRUCTURE
TECHNICAL CRITERIA
DIAGRAM AND DETAILS**

B.24

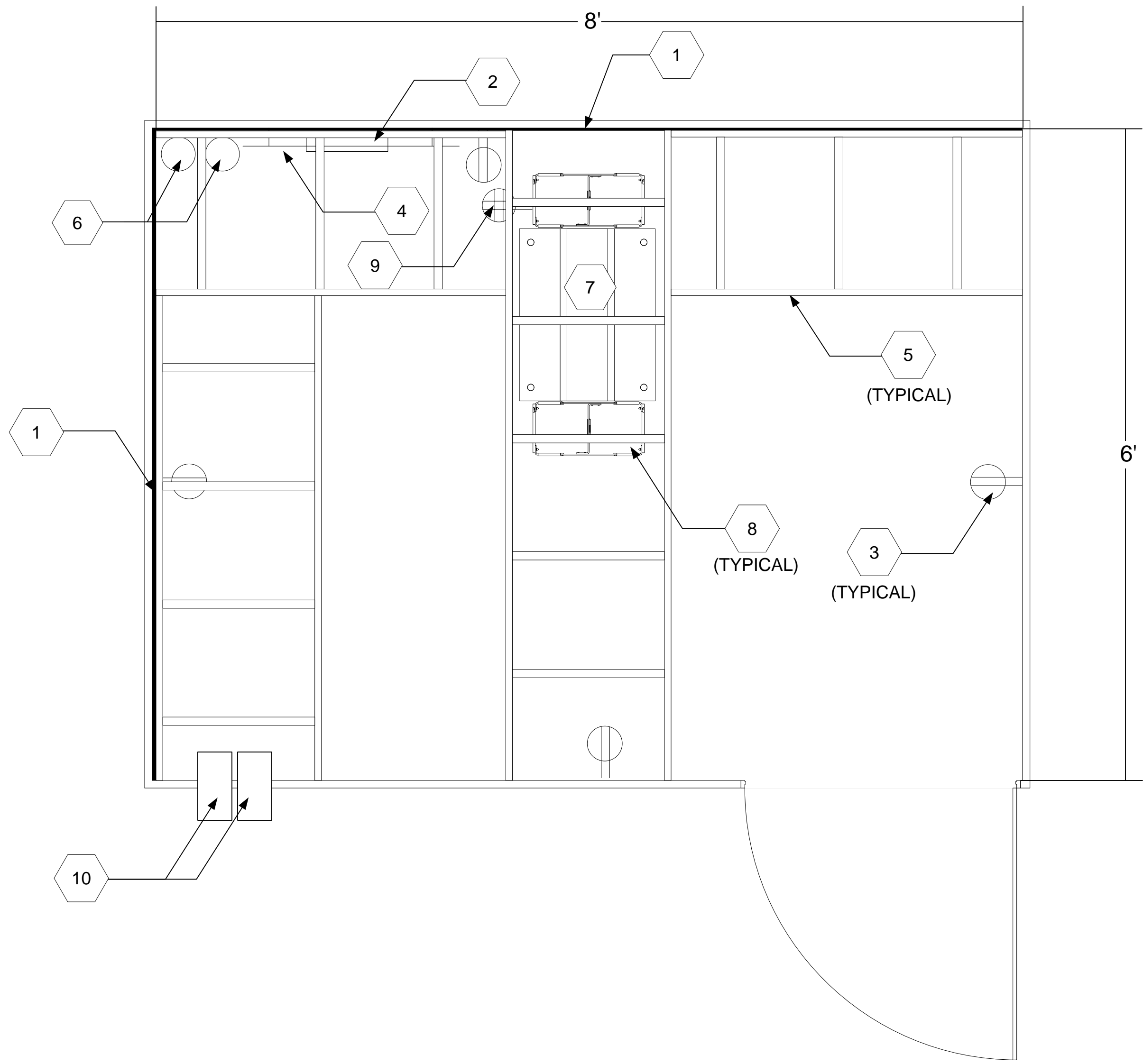

TYPICAL OMS TR AERIAL DIAGRAM

SHEET KEY NOTES

- 1 IPS CONTAINER. (GOVERNMENT FURNISHED, CONTRACTOR INSTALLED)
- 2 2 INCH X 12 INCH TGB. MOUNT VERTICAL AT 30 INCHES AFF IMMEDIATELY ADJACENT TO THE IPS CONTAINER
- 3 HARDENED PDS (COLOR RED IS FOR ILLUSTRATIVE PURPOSES ONLY)
- 4 LOCKABLE OUTLET BOX (COLOR RED IS FOR ILLUSTRATIVE PURPOSES ONLY)
- 5 STANDARD ICT INFRASTRUCTURE OUTLET WITH 3 JACKS FOR SECURE FAX AND SECURE VOICE
- 6 DEDICATED DOUBLE DUPLEX NEMA 5-20R RECEPTACLE. MOUNT AT STANDARD RECEPTACLE HEIGHT IMMEDIATELY ADJACENT TO THE IPS CONTAINER
- 7 STANDARD ICT OUTLET FOR IPS CONTAINER. INSTALL IMMEDIATELY ADJACENT TO THE SIPRNET IPS CONTAINER AT STANDARD OUTLET HEIGHT
- 8 USARC APPROVED COMBINATION PAD LOCK (FOR OUTLET BOX COVER)
- 9 1 INCH EMT CONDUIT TO THE APPROPRIATE TER/TR

SHEET GENERAL NOTES

1. ALL DIAGRAMS ILLUSTRATE REQUIRED COMPONENTS AS WELL AS MOUNTING AND SPACING DETAILS FOR THESE COMPONENTS. DIAGRAMS ALSO ILLUSTRATE THE PREFERRED LAYOUT FOR THESE COMPONENTS BASED ON STANDARD ROOM LAYOUTS. THE DIAGRAMS DO NOT NECESSARILY ILLUSTRATE THE QUANTITY REQUIRED OF EACH COMPONENT NOR THE ACTUAL LOCATION FOR THESE COMPONENTS. EXACT QUANTITY AND LOCATION WILL BE DETERMINED DURING THE DESIGN AND CONSTRUCTION PROCESSES.

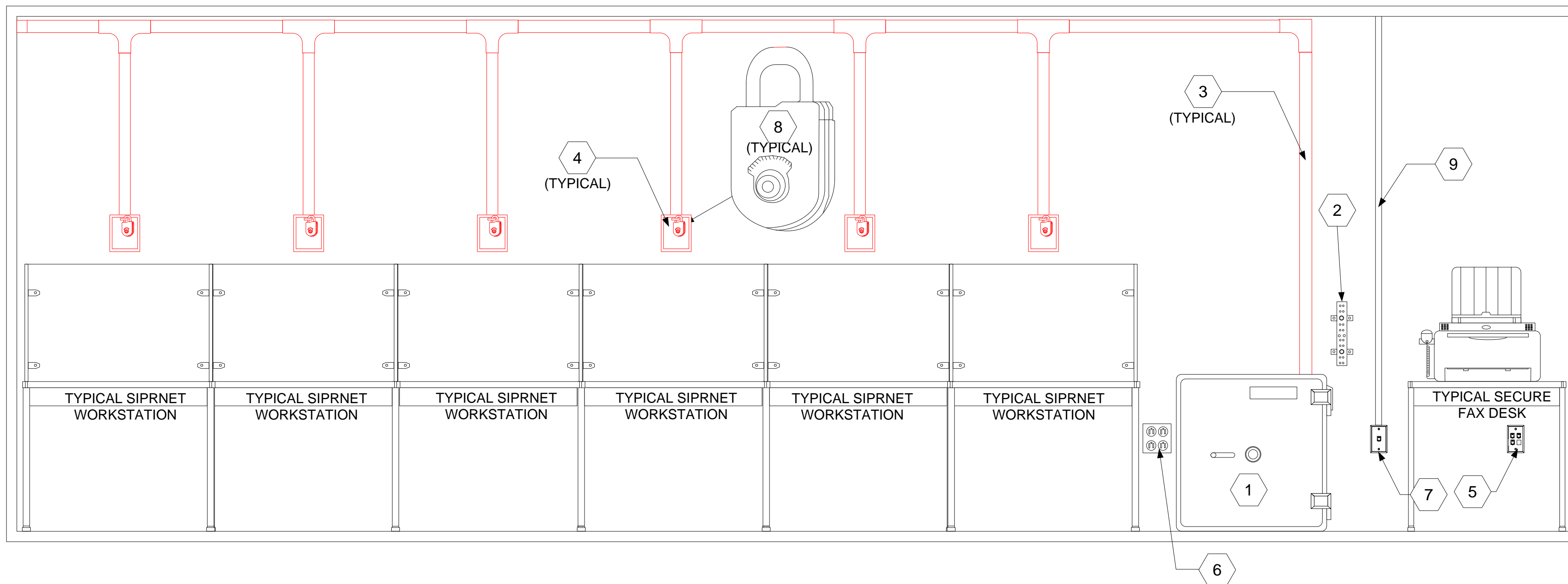

TYPICAL DEDICATED SIPRNET ROOM WALL ELEVATION DIAGRAM



SYMBOL	REVISIONS DESCRIPTION	DATE	APPR.

DESIGNED BY: JOHN BABB	DESIGNED BY: DEREK MITCHELL	REVIEWED BY: ROBERT BABB	USARC G-6 RCDD
DATE: JUNE 2016		FOR OFFICIAL USE ONLY	

**USARC G-6
NETWORKING AND
INFRASTRUCTURE
BRANCH
INFRASTRUCTURE
TEAM**

**U.S. ARMY RESERVE
NETWORK ENTERPRISE CENTER
INFRASTRUCTURE
TECHNICAL CRITERIA
DIAGRAM AND DETAILS**

B.25

SHEET GENERAL NOTES

1. ALL DIAGRAMS ILLUSTRATE REQUIRED COMPONENTS AS WELL AS MOUNTING AND SPACING DETAILS FOR THESE COMPONENTS. DIAGRAMS ALSO ILLUSTRATE THE PREFERRED LAYOUT FOR THESE COMPONENTS BASED ON STANDARD ROOM LAYOUTS. THE DIAGRAMS DO NOT NECESSARILY ILLUSTRATE THE QUANTITY REQUIRED OF EACH COMPONENT NOR THE ACTUAL LOCATION FOR THESE COMPONENTS. EXACT QUANTITY AND LOCATION WILL BE DETERMINED DURING THE DESIGN AND CONSTRUCTION PROCESSES.

SHEET KEY NOTES

- 1 IPS CONTAINER. (GOVERNMENT FURNISHED, CONTRACTOR INSTALLED)
- 2 2 INCH X 12 INCH TGB. MOUNT VERTICAL AT 30 INCHES AFF IMMEDIATELY ADJACENT TO THE IPS CONTAINER
- 3 STANDARD ICT INFRASTRUCTURE OUTLET WITH 3 JACKS FOR SECURE FAX AND SECURE VOICE
- 4 HARDENED PDS (COLOR RED IS FOR ILLUSTRATIVE PURPOSES ONLY)
- 5 DEDICATED DOUBLE DUPLEX NEMA 5-20R RECEPTACLE. MOUNT AT STANDARD RECEPTACLE HEIGHT IMMEDIATELY ADJACENT TO THE IPS CONTAINER
- 6 STANDARD ICT OUTLET FOR IPS CONTAINER. INSTALL IMMEDIATELY ADJACENT TO THE SIPRNET IPS CONTAINER AT STANDARD OUTLET HEIGHT

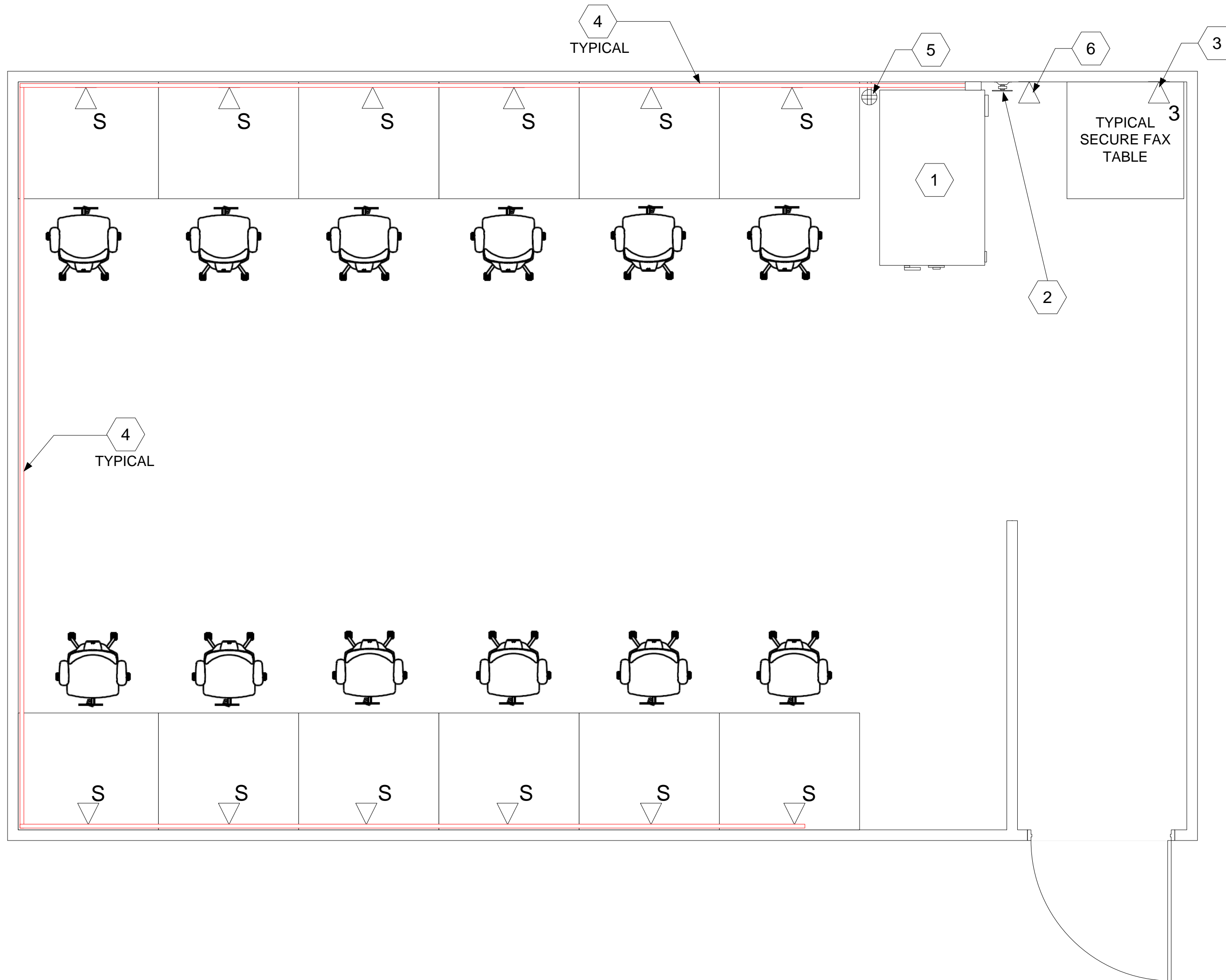

TYPICAL DEDICATED SIPRNET ROOM AERIAL DIAGRAM



REVISIONS	DATE	APPR.

DESIGNED BY: JOHN BABB	DATE: JUNE 2016	FOR OFFICIAL USE ONLY
DESIGNED BY: DEREK MITCHELL		
REVIEWED BY: ROBERT BABB		
USARC G-6 RCDD		

USARC G-6
NETWORKING AND
INFRASTRUCTURE
BRANCH
INFRASTRUCTURE
TEAM

U.S. ARMY RESERVE
NETWORK ENTERPRISE CENTER
INFRASTRUCTURE
TECHNICAL CRITERIA
DIAGRAM AND DETAILS

B.26

SHEET GENERAL NOTES

1. ALL DIAGRAMS ILLUSTRATE REQUIRED COMPONENTS AS WELL AS MOUNTING AND SPACING DETAILS FOR THESE COMPONENTS. DIAGRAMS ALSO ILLUSTRATE THE PREFERRED LAYOUT FOR THESE COMPONENTS BASED ON STANDARD ROOM LAYOUTS. THE DIAGRAMS DO NOT NECESSARILY ILLUSTRATE THE QUANTITY REQUIRED OF EACH COMPONENT NOR THE ACTUAL LOCATION FOR THESE COMPONENTS. EXACT QUANTITY AND LOCATION WILL BE DETERMINED DURING THE DESIGN AND CONSTRUCTION PROCESSES.

SHEET KEY NOTES

- 1 IPS CONTAINER. (GOVERNMENT FURNISHED, CONTRACTOR INSTALLED)
- 2 DEDICATED DOUBLE DUPLEX NEMA 5-20R RECEPTACLE. MOUNT AT STANDARD RECEPTACLE HEIGHT IMMEDIATELY ADJACENT TO THE IPS CONTAINER
- 3 STANDARD ICT OUTLET FOR IPS CONTAINER. INSTALL IMMEDIATELY ADJACENT TO THE SIPRNET IPS CONTAINER AT STANDARD OUTLET HEIGHT
- 4 1 INCH EMT CONDUIT TO THE APPROPRIATE TER/TR



SYMBOL	REVISIONS DESCRIPTION	DATE	APPR.

DESIGNED BY: JOHN BABB	DATE: JUNE 2016
DESIGNED BY: DEREK MITCHELL	FOR OFFICIAL USE ONLY
REVIEWED BY: ROBERT BABB	
USARC G-6 RCDD	

**USARC G-6
NETWORKING AND
INFRASTRUCTURE
BRANCH
INFRASTRUCTURE
TEAM**

**U.S. ARMY RESERVE
NETWORK ENTERPRISE CENTER
INFRASTRUCTURE
TECHNICAL CRITERIA
DIAGRAM AND DETAILS**

B.27



TYPICAL STANDARD SIPRNET WALL ELEVATION DIAGRAM

SHEET GENERAL NOTES

1. ALL DIAGRAMS ILLUSTRATE REQUIRED COMPONENTS AS WELL AS MOUNTING AND SPACING DETAILS FOR THESE COMPONENTS. DIAGRAMS ALSO ILLUSTRATE THE PREFERRED LAYOUT FOR THESE COMPONENTS BASED ON STANDARD ROOM LAYOUTS. THE DIAGRAMS DO NOT NECESSARILY ILLUSTRATE THE QUANTITY REQUIRED OF EACH COMPONENT NOR THE ACTUAL LOCATION FOR THESE COMPONENTS. EXACT QUANTITY AND LOCATION WILL BE DETERMINED DURING THE DESIGN AND CONSTRUCTION PROCESSES.

SHEET KEY NOTES

- 1 IPS CONTAINER. (GOVERNMENT FURNISHED, CONTRACTOR INSTALLED)
- 2 DEDICATED DOUBLE DUPLEX NEMA 5-20R RECEPTACLE. MOUNT AT STANDARD RECEPTACLE HEIGHT IMMEDIATELY ADJACENT TO THE IPS CONTAINER
- 3 STANDARD ICT OUTLET FOR IPS CONTAINER. INSTALL IMMEDIATELY ADJACENT TO THE SIPRNET IPS CONTAINER AT STANDARD OUTLET HEIGHT



SYMBOL	REVISIONS DESCRIPTION	DATE	APPR.

DESIGNED BY: JOHN BABB	DATE: JUNE 2016
DESIGNED BY: DEREK MITCHELL	FOR OFFICIAL USE ONLY
REVIEWED BY: ROBERT BABB	USARC G-6 RCDD

USARC G-6
NETWORKING AND
INFRASTRUCTURE
BRANCH
INFRASTRUCTURE
TEAM

U.S. ARMY RESERVE
NETWORK ENTERPRISE CENTER
INFRASTRUCTURE
TECHNICAL CRITERIA
DIAGRAM AND DETAILS

B.28

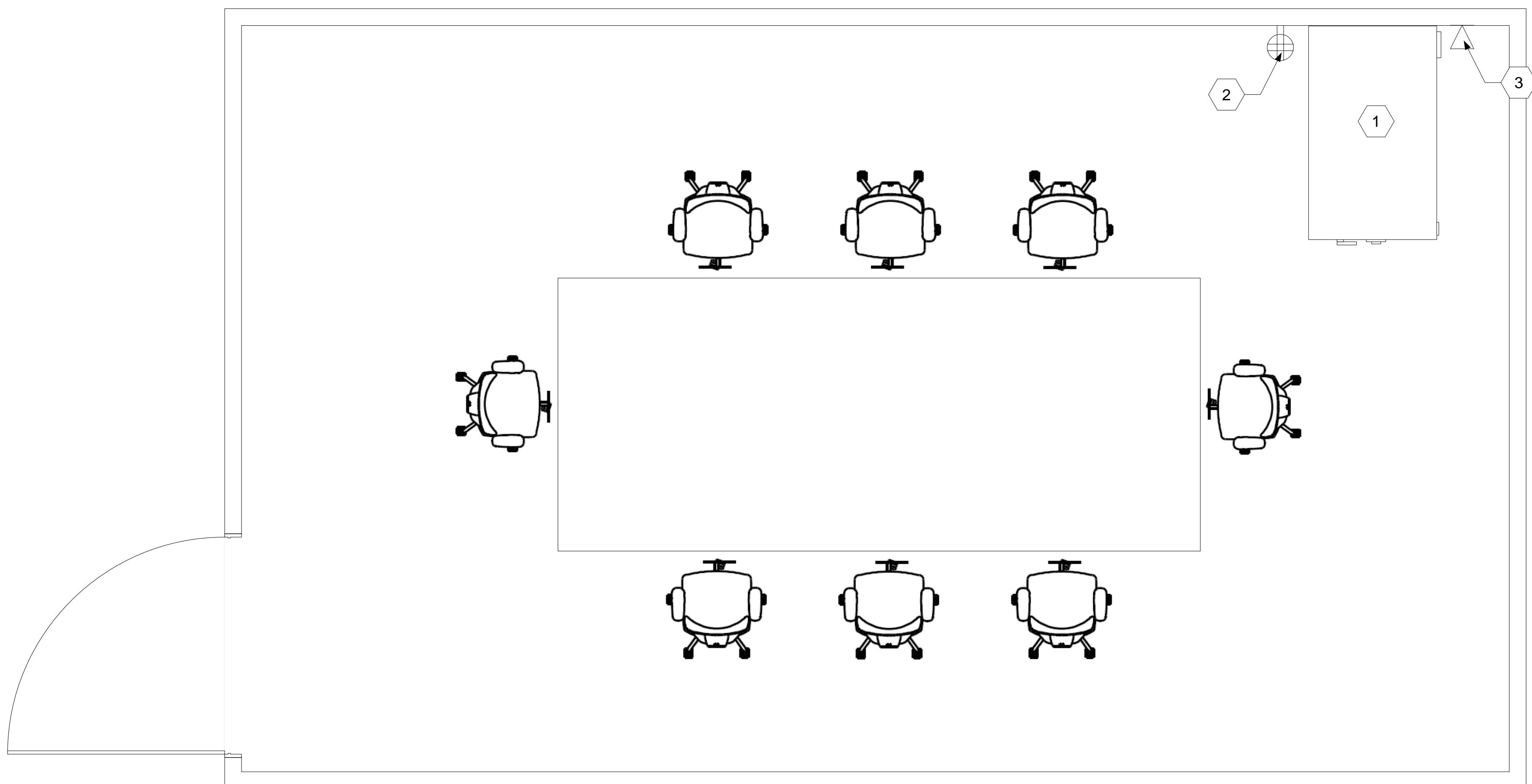

TYPICAL STANDARD SIPRNET ROOM AERIAL DIAGRAM

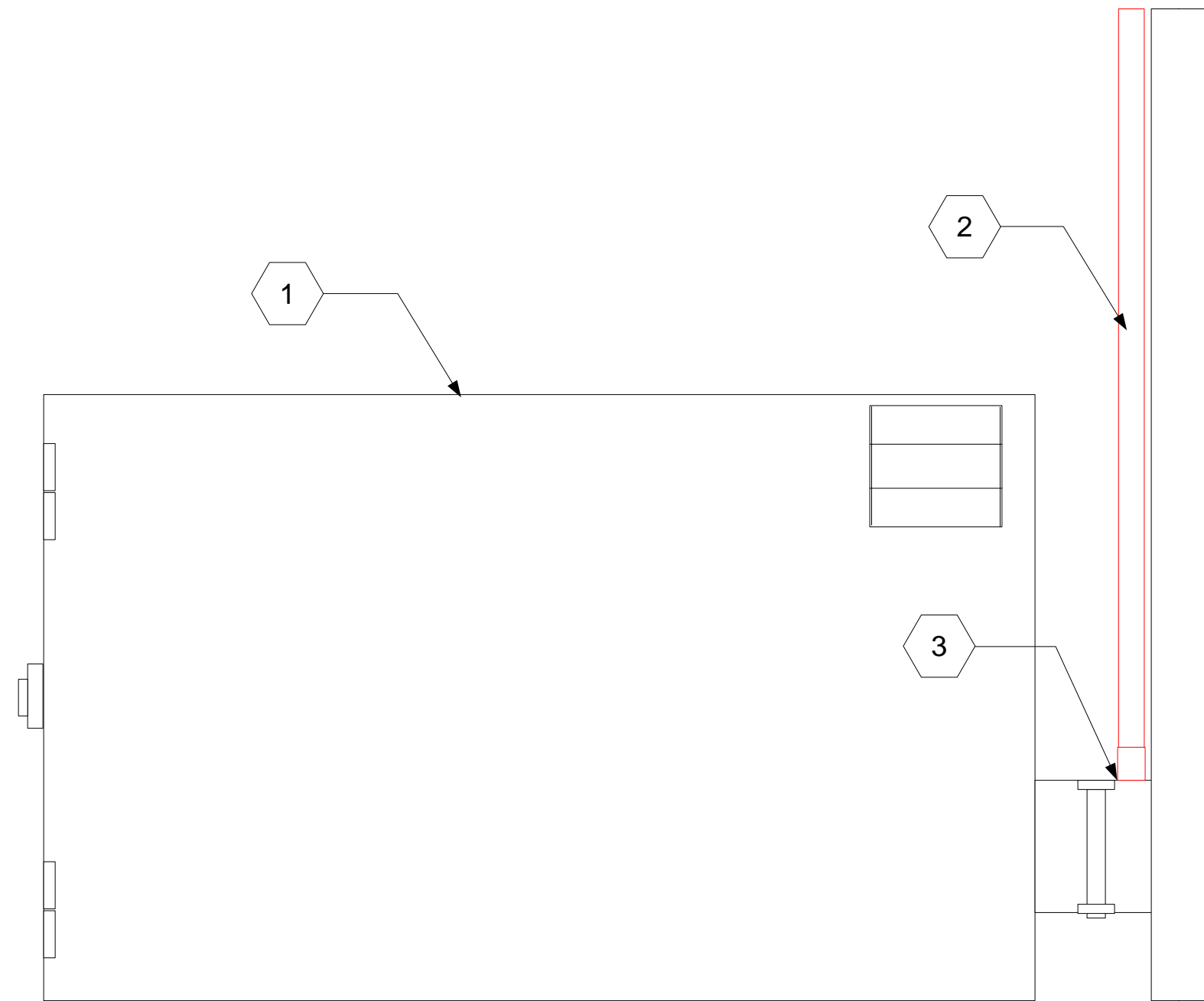

1 IPS CONTAINER SIDE DIAGRAM

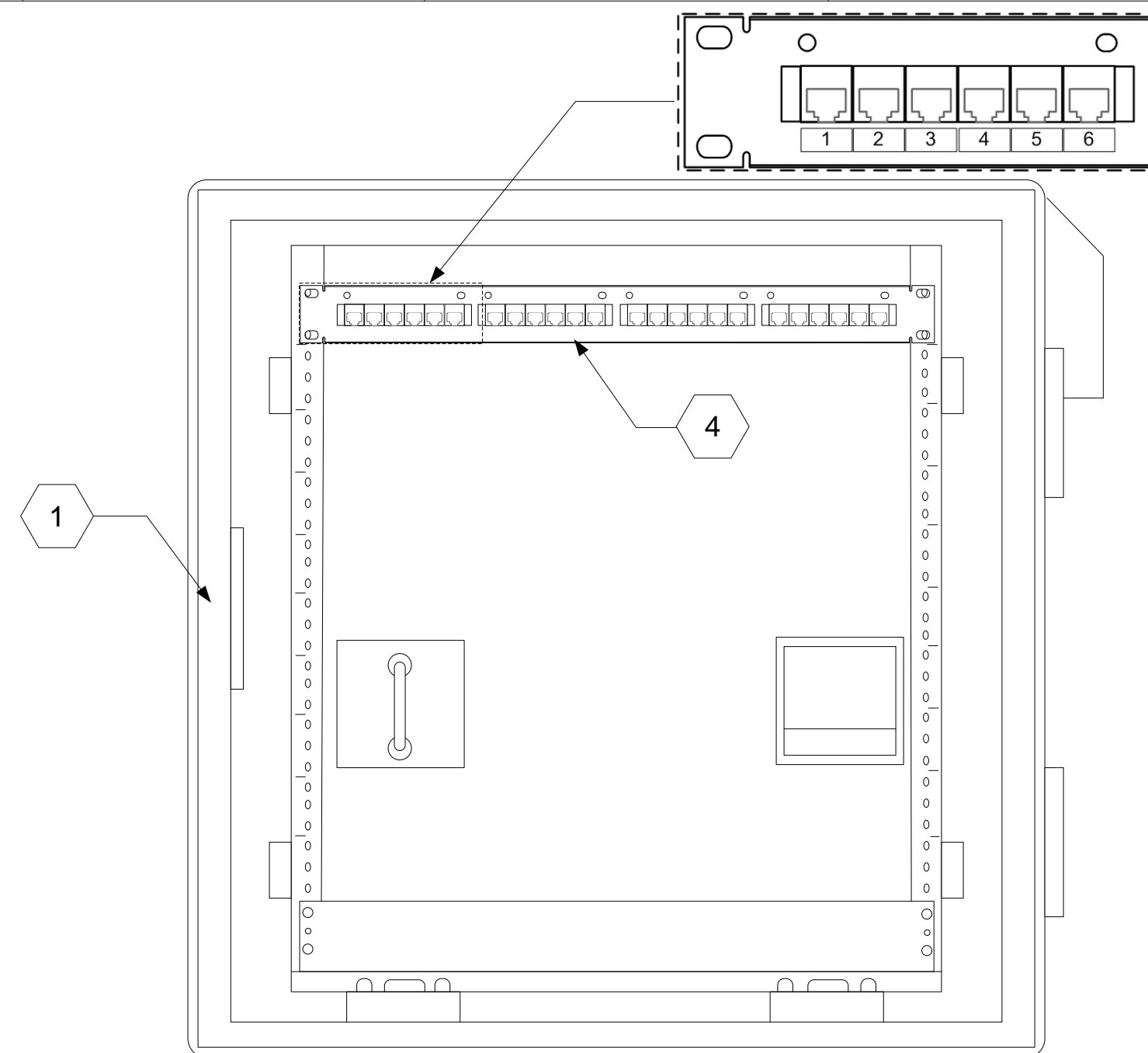

2 IPS CONTAINER FRONT DIAGRAM

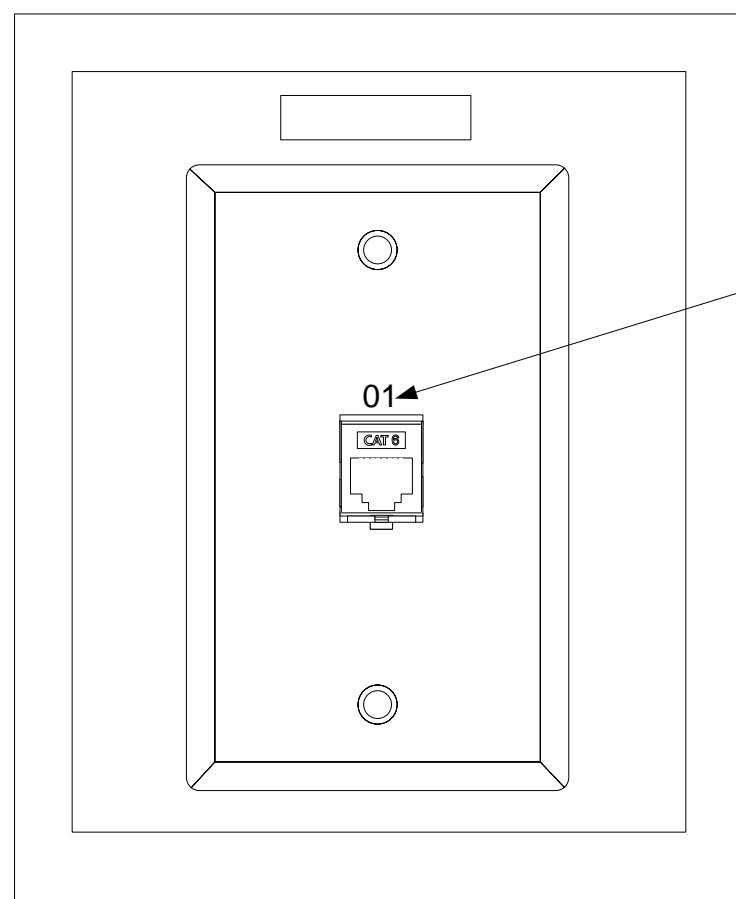

3 TYPICAL SIPR WORKSTATION ICT OUTLET

SHEET KEY NOTES

- 1 IPS CONTAINER. (GOVERNMENT FURNISHED, CONTRACTOR INSTALLED)
- 2 HARDENED PDS (COLOR RED IS FOR ILLUSTRATIVE PURPOSES ONLY)
- 3 HARDENED PDS SECURED TO BACK OF IPS CONTAINER
- 4 CATEGORY 6 PATCH PANEL

SHEET GENERAL NOTES

1. ALL DIAGRAMS ILLUSTRATE REQUIRED COMPONENTS AS WELL AS MOUNTING AND SPACING DETAILS FOR THESE COMPONENTS. DIAGRAMS ALSO ILLUSTRATE THE PREFERRED LAYOUT FOR THESE COMPONENTS BASED ON STANDARD ROOM LAYOUTS. THE DIAGRAMS DO NOT NECESSARILY ILLUSTRATE THE QUANTITY REQUIRED OF EACH COMPONENT NOR THE ACTUAL LOCATION FOR THESE COMPONENTS. EXACT QUANTITY AND LOCATION WILL BE DETERMINED DURING THE DESIGN AND CONSTRUCTION PROCESSES.

TYPICAL SIPRNET ENLARGED COMPONENTS DIAGRAMS



SYMBOL	REVISIONS DESCRIPTION	DATE	APPR.

DESIGNED BY: JOHN BABB	DESIGNED BY: DEREK MITCHELL	REVIEWED BY: ROBERT BABB	USARC G-6 RCDD
DATE: JUNE 2016	FOR OFFICIAL USE ONLY		

USARC G-6
NETWORKING AND
INFRASTRUCTURE
BRANCH
INFRASTRUCTURE
TEAM

U.S. ARMY RESERVE
NETWORK ENTERPRISE CENTER
INFRASTRUCTURE
TECHNICAL CRITERIA
DIAGRAM AND DETAILS

SHEET KEY NOTES

- 1 IPS CONTAINER. (GOVERNMENT FURNISHED, CONTRACTOR INSTALLED)
- 2 HARDENED PDS. PDS MUST BE EXPOSED AND ABLE TO BE INSPECTED BELOW THE FINISHED CEILING LEVEL (COLOR RED IS FOR ILLUSTRATIVE PURPOSES ONLY)
- 3 LOCKABLE OUTLET BOX
- 4 USARC APPROVED COMBINATION PAD LOCK (FOR OUTLET BOX COVER) (COLOR RED IS FOR ILLUSTRATIVE PURPOSES ONLY)

SHEET GENERAL NOTES

1. ALL DIAGRAMS ILLUSTRATE REQUIRED COMPONENTS AS WELL AS MOUNTING AND SPACING DETAILS FOR THESE COMPONENTS. DIAGRAMS ALSO ILLUSTRATE THE PREFERRED LAYOUT FOR THESE COMPONENTS BASED ON STANDARD ROOM LAYOUTS. THE DIAGRAMS DO NOT NECESSARILY ILLUSTRATE THE QUANTITY REQUIRED OF EACH COMPONENT NOR THE ACTUAL LOCATION FOR THESE COMPONENTS. EXACT QUANTITY AND LOCATION WILL BE DETERMINED DURING THE DESIGN AND CONSTRUCTION PROCESSES.



SYMBOL	REVISIONS	DATE	APPR.
	DESCRIPTION		

DESIGNED BY: JOHN BABB	DATE: JUNE 2016	FOR OFFICIAL USE ONLY
DESIGNED BY: DEREK MITCHELL		
REVIEWED BY: ROBERT BABB		
USARC G-6 RCDD		

USARC G-6 NETWORKING AND INFRASTRUCTURE BRANCH INFRASTRUCTURE TEAM

U.S. ARMY RESERVE NETWORK ENTERPRISE CENTER INFRASTRUCTURE TECHNICAL CRITERIA DIAGRAM AND DETAILS

B.30

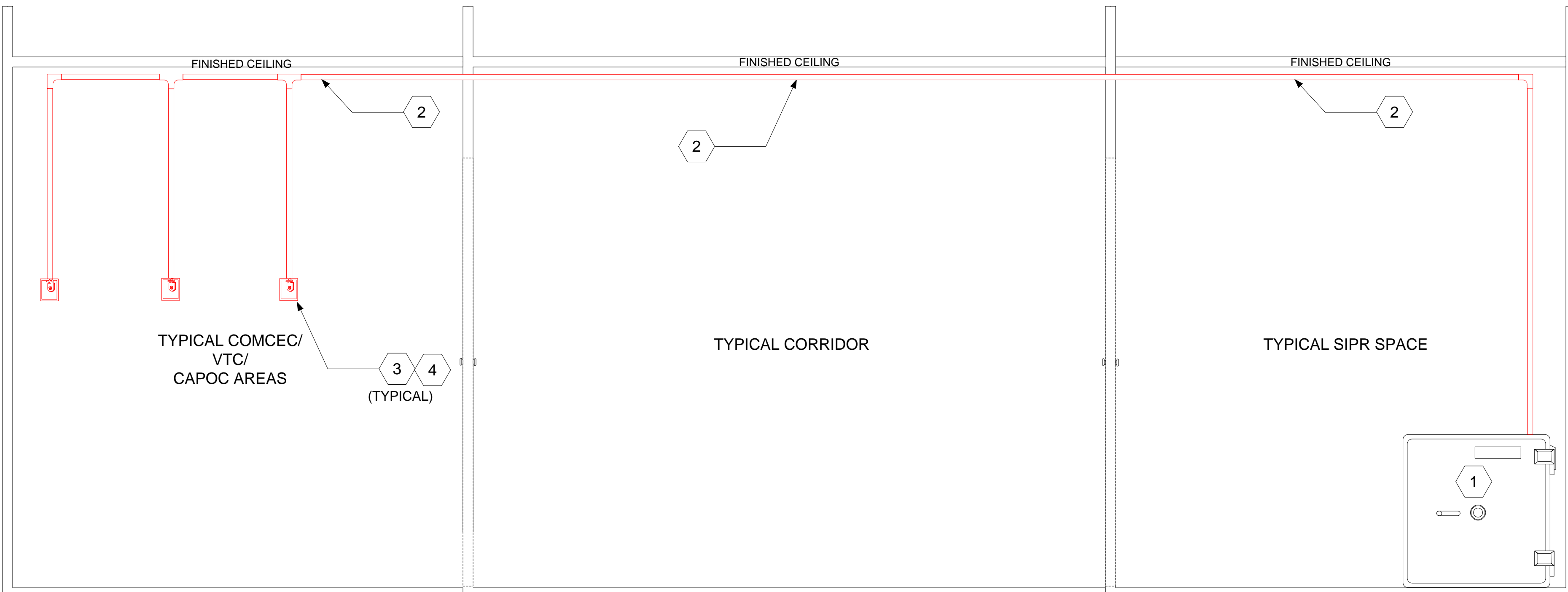

TYPICAL ADDITIONAL SIPRNET DROPS ELEVATION DIAGRAM

SHEET GENERAL NOTES

1. ALL DIAGRAMS ILLUSTRATE REQUIRED COMPONENTS AS WELL AS MOUNTING AND SPACING DETAILS FOR THESE COMPONENTS. DIAGRAMS ALSO ILLUSTRATE THE PREFERRED LAYOUT FOR THESE COMPONENTS BASED ON STANDARD ROOM LAYOUTS. THE DIAGRAMS DO NOT NECESSARILY ILLUSTRATE THE QUANTITY REQUIRED OF EACH COMPONENT NOR THE ACTUAL LOCATION FOR THESE COMPONENTS. EXACT QUANTITY AND LOCATION WILL BE DETERMINED DURING THE DESIGN AND CONSTRUCTION PROCESSES.

SHEET KEY NOTES

- 1 IPS CONTAINER. (GOVERNMENT FURNISHED, CONTRACTOR INSTALLED)
- 2 HARDENED PDS. PDS MUST BE EXPOSED AND ABLE TO BE INSPECTED BELOW THE FINISHED CEILING LEVEL (COLOR RED IS FOR ILLUSTRATIVE PURPOSES ONLY)
- 3 LOCKABLE OUTLET BOX
- 4 USARC APPROVED COMBINATION PAD LOCK (FOR OUTLET BOX COVER)



SYMBOL	REVISIONS DESCRIPTION	DATE	APPR.

DESIGNED BY: JOHN BABB	DATE: JUNE 2016
DESIGNED BY: DEREK MITCHELL	FOR OFFICIAL USE ONLY
REVIEWED BY: ROBERT BABB	
USARC G-6 RCDD	

USARC G-6
NETWORKING AND
INFRASTRUCTURE
BRANCH
INFRASTRUCTURE
TEAM

U.S. ARMY RESERVE
NETWORK ENTERPRISE CENTER
INFRASTRUCTURE
TECHNICAL CRITERIA
DIAGRAM AND DETAILS

B.31

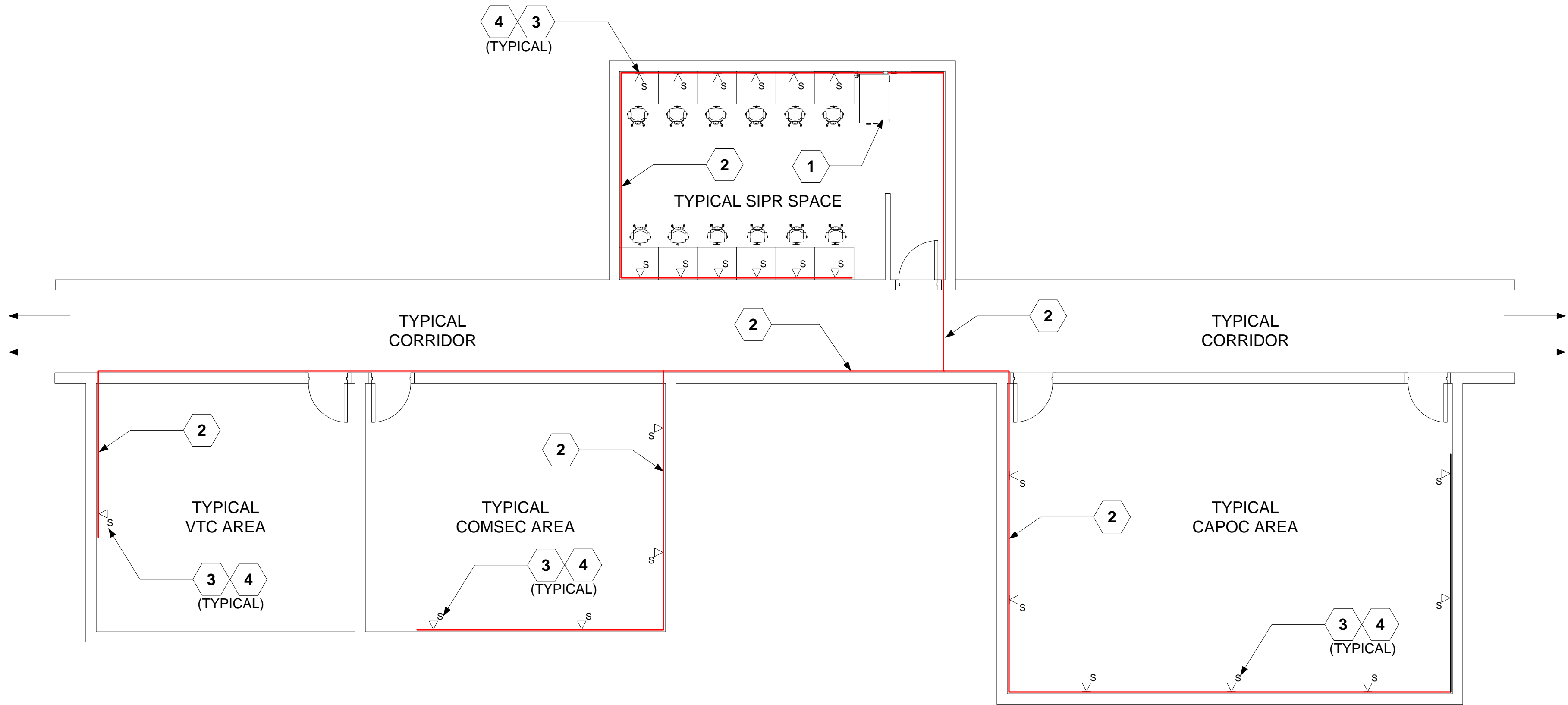

TYPICAL ADDITIONAL SIPRNET DROPS AERIAL DIAGRAM

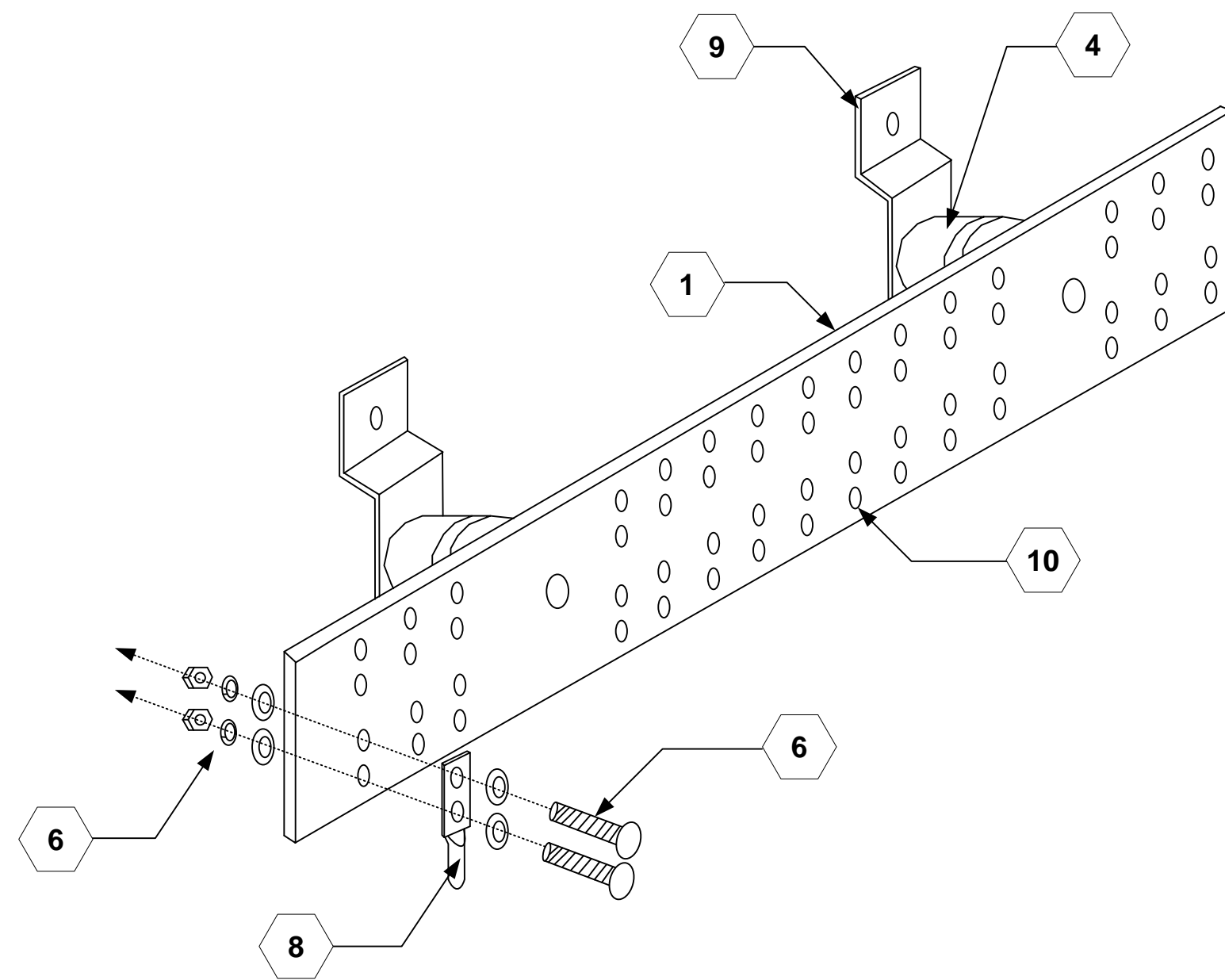

1 TMGB ENLARGED DETAIL

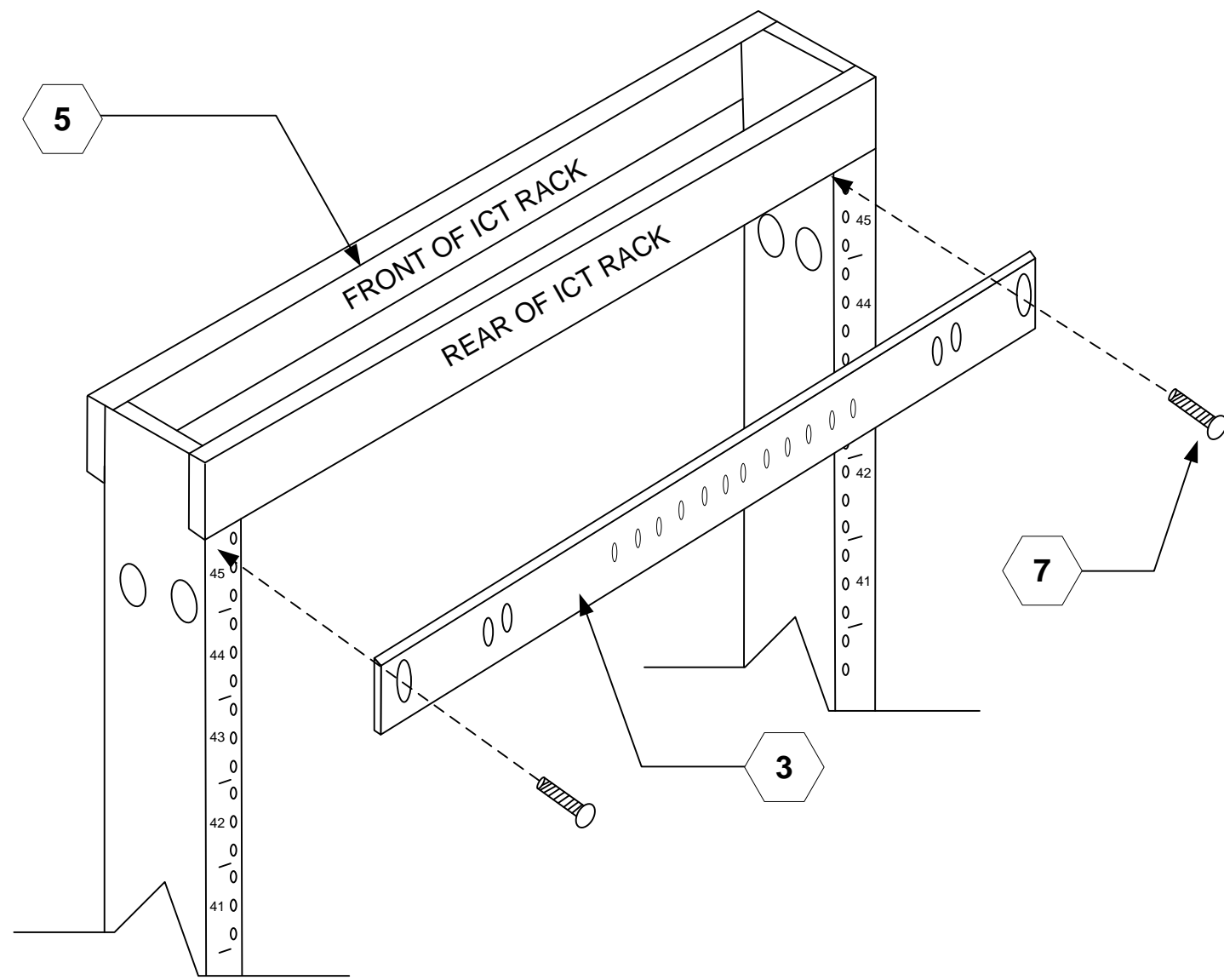

2 RACK MOUNTED BUS-BAR ENLARGED DETAIL

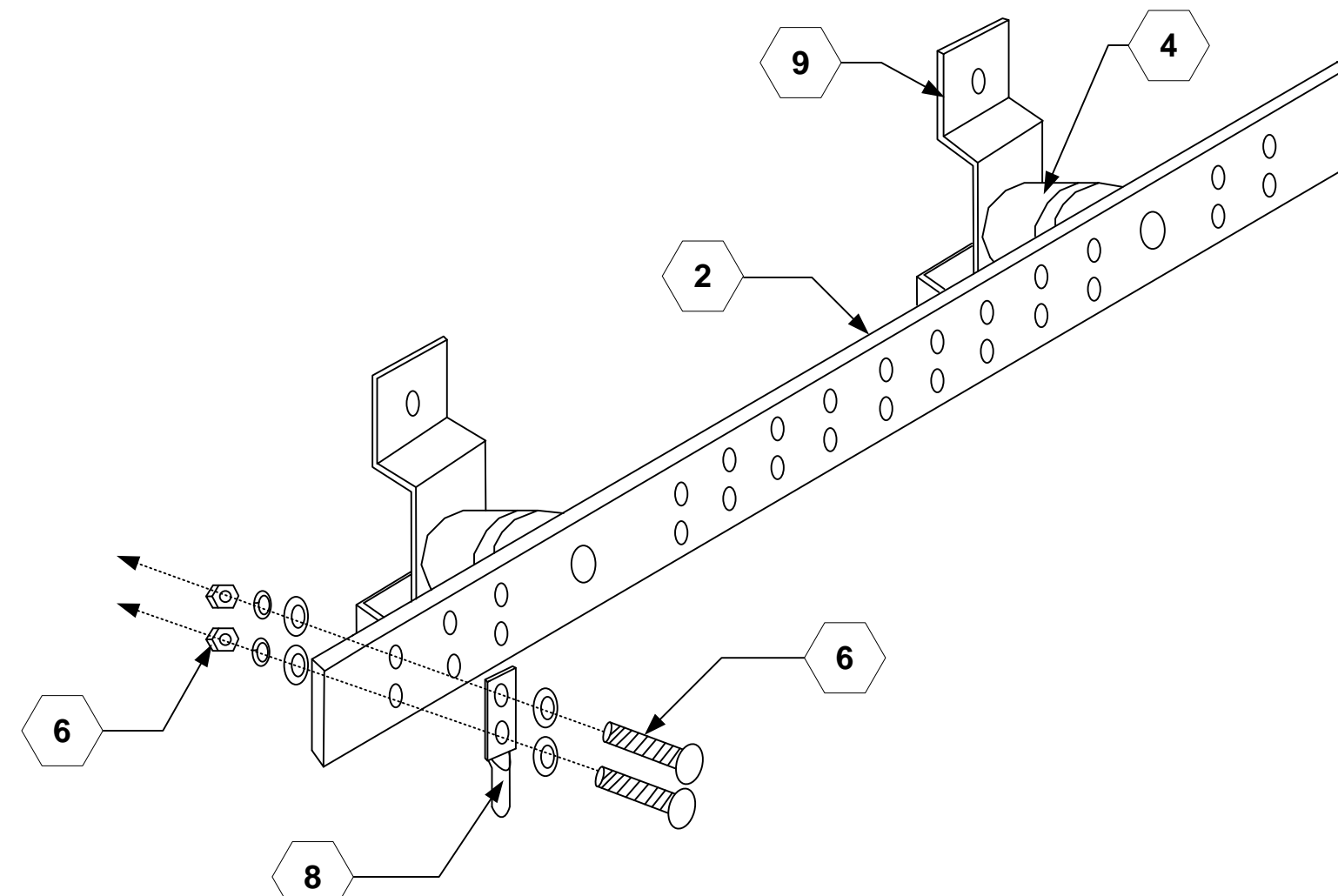

3 TGB ENLARGED DETAIL

SHEET KEY NOTES

- 1 TMGB
- 2 TGB
- 3 RGB
- 4 INSULATOR
- 5 ICT RACK
- 6 STANDARD HARDWARE
- 7 STANDARD RACK HARDWARE
- 8 GROUNDING CONNECTOR
- 9 MOUNTING BRACKET



SYMBOL	REVISIONS	DATE	APPR.
	DESCRIPTION		

DESIGNED BY: JOHN BABB	DATE: JUNE 2016
DESIGNED BY: DEREK MITCHELL	FOR OFFICIAL USE ONLY
REVIEWED BY: ROBERT BABB	
USARC G-6 RCDD	

USARC G-6
NETWORKING AND
INFRASTRUCTURE
BRANCH
INFRASTRUCTURE
TEAM

U.S. ARMY RESERVE
NETWORK ENTERPRISE CENTER
INFRASTRUCTURE
TECHNICAL CRITERIA
DIAGRAM AND DETAILS

TYPICAL TELECOMMUNICATION GROUNDING BUS-BAR ENLARGED DIAGRAMS

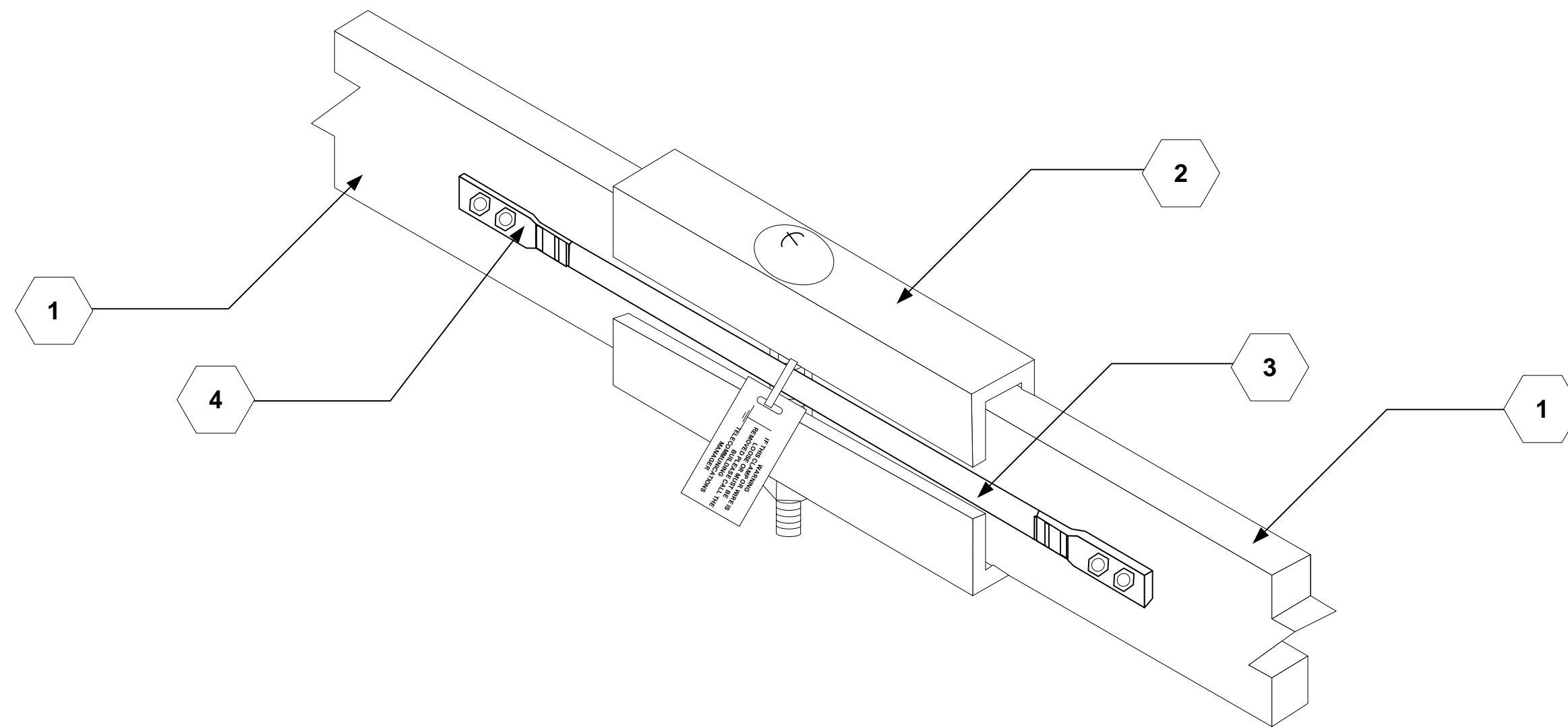

1 LADDER RACK GROUNDING STRAP ENLARGED DETAIL

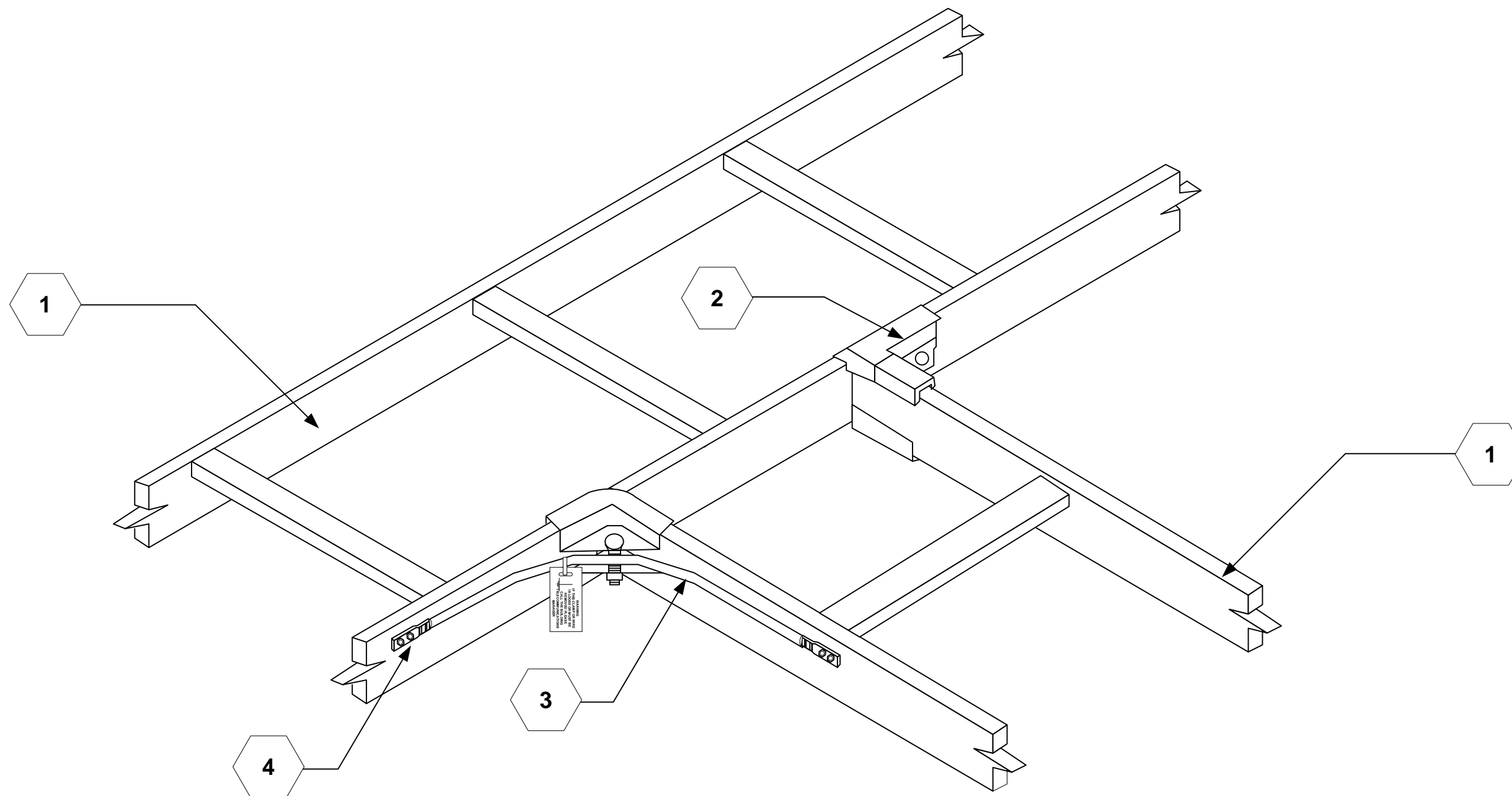

2 LADDER RACK GROUNDING STRAP ENLARGED DETAIL

SHEET KEY NOTES

- 1 LADDER RACK SUPPORT SYSTEM SECTION
- 2 LADDER RACK SUPPORT SYSTEM SECTION CONNECTOR
- 3 GROUNDING CONDUCTOR
- 4 GROUNDING CONNECTOR



SYMBOL	REVISIONS DESCRIPTION	DATE	APPR.

DESIGNED BY: JOHN BABB	DATE: JUNE 2016
DESIGNED BY: DEREK MITCHELL	FOR OFFICIAL USE ONLY
REVIEWED BY: ROBERT BABB	
USARC G-6 RCDD	

USARC G-6
NETWORKING AND
INFRASTRUCTURE
BRANCH
INFRASTRUCTURE
TEAM

U.S. ARMY RESERVE
NETWORK ENTERPRISE CENTER
INFRASTRUCTURE
TECHNICAL CRITERIA
DIAGRAM AND DETAILS

B.33

TYPICAL LADDER RACK GROUNDING DIAGRAMS

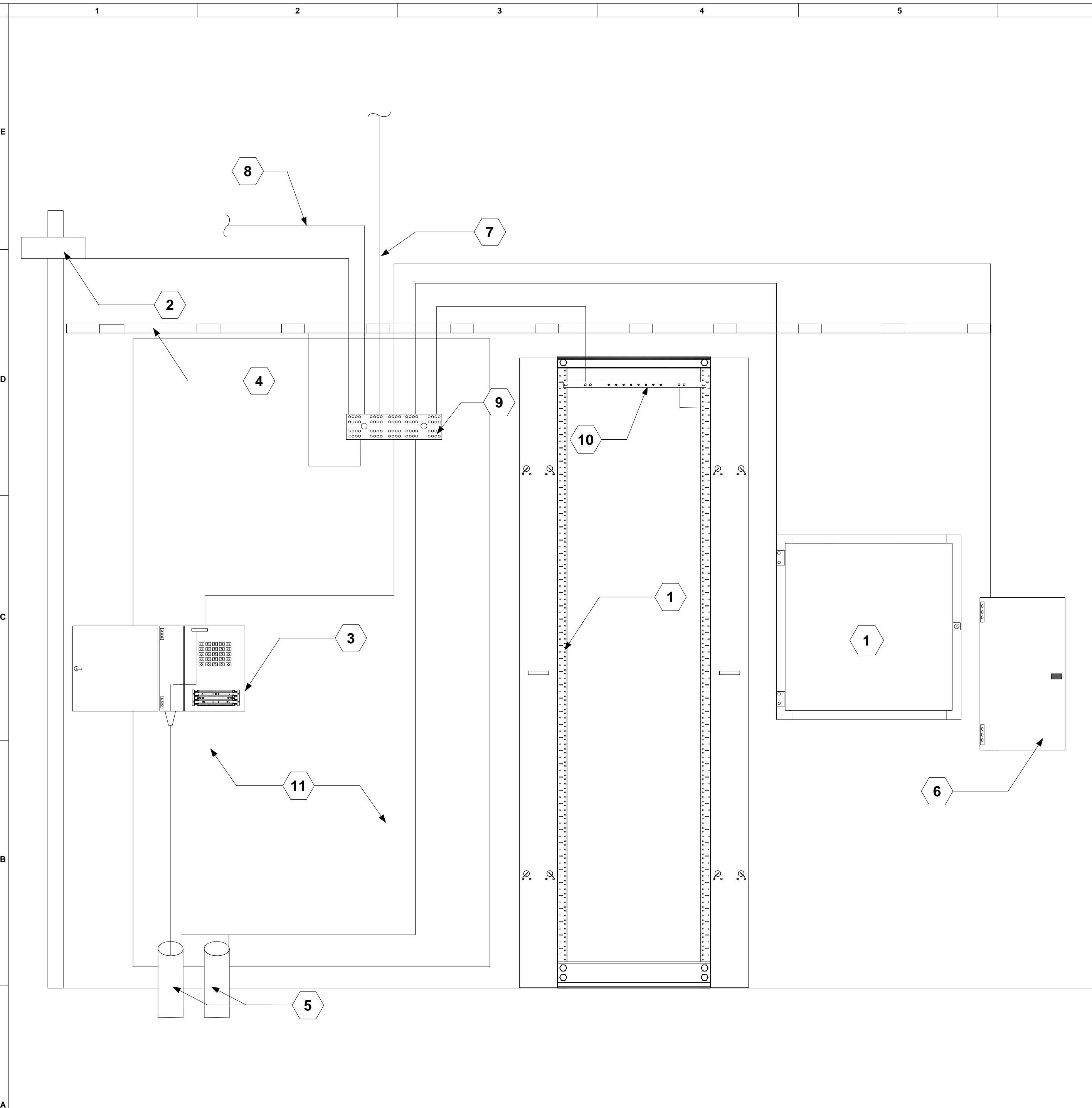

SHEET KEY NOTES

- 1 ICT RACKS / ICT CABINETS
- 2 WALL SLEEVE/MECHANICAL FIRE STOP/
OVERHEAD METALLIC CONDUIT
- 3 BUILDING ENTRANCE TERMINAL
- 4 LADDER RACK SUPPORT SYSTEM
- 5 METALLIC CONDUITS
- 6 ELECTRICAL PANEL
- 7 GROUNDING CONDUCTOR TO BUILDING
STEEL
- 8 GROUNDING CONDUCTOR TO TMGB (IF
APPLICABLE)
- 9 TMGB/TGB
- 10 RACK MOUNTED BUS-BAR
- 11 PLYWOOD BACKBOARD



SYMBOL	REVISIONS DESCRIPTION	DATE	APPR.

DESIGNED BY:
JOHN BABB

DESIGNED BY:
DEREK MITCHELL

REVIEWED BY:
ROBERT BABB

USARC G-6 RCDD

DATE:
JUNE 2016

**FOR
OFFICIAL
USE ONLY**

**USARC G-6
NETWORKING AND
INFRASTRUCTURE
BRANCH
INFRASTRUCTURE
TEAM**

**U.S. ARMY RESERVE
NETWORK ENTERPRISE CENTER
INFRASTRUCTURE
TECHNICAL CRITERIA
DIAGRAM AND DETAILS**

TYPICAL GROUNDING RISER DIAGRAM

SHEET KEY NOTES

- 1 SERVICE PROVIDER INSTALLED COPPER BACKBONE CABLE
- 2 SERVICE PROVIDER INSTALLED SM FIBER OPTIC CABLE
- 3 DS3 COAXIAL EXTENSION
- 4 (12) CAT. 6 CABLES
- 5 12 STRAND SM FIBER OPTIC CABLE
- 6 25 PAIR COPPER BACKBONE CABLE



SYMBOL	REVISIONS DESCRIPTION	DATE	APPR.

DESIGNED BY: JOHN BABB	DATE: JUNE 2016
DESIGNED BY: DEREK MITCHELL	FOR OFFICIAL USE ONLY
REVIEWED BY: ROBERT BABB	
USARC G-6 NETWORKING AND INFRASTRUCTURE BRANCH	USARC G-6 RCDD

USARC G-6
NETWORKING AND
INFRASTRUCTURE
BRANCH
INFRASTRUCTURE
TEAM

U.S. ARMY RESERVE
NETWORK ENTERPRISE CENTER
INFRASTRUCTURE
TECHNICAL CRITERIA
DIAGRAM AND DETAILS

B.35

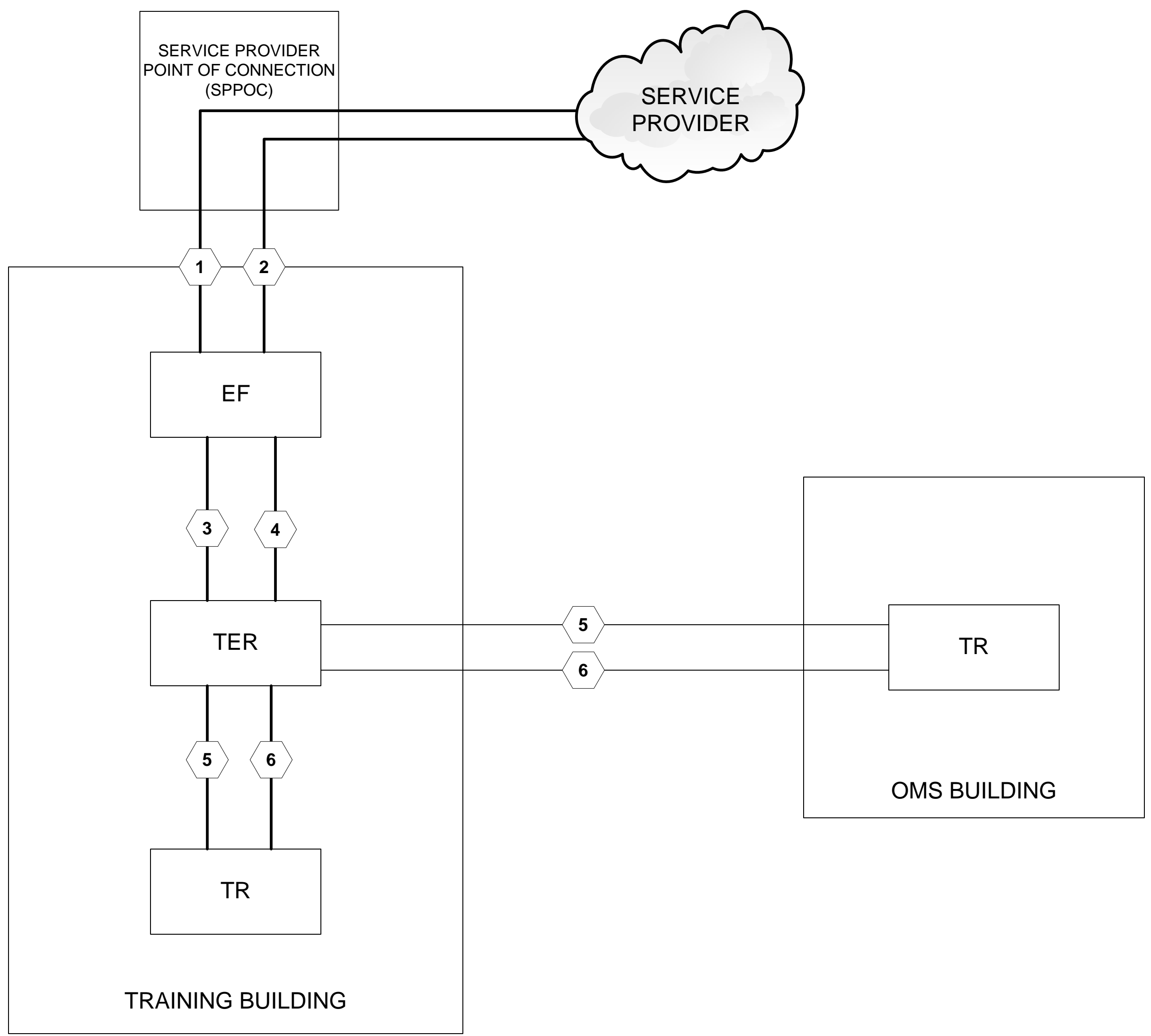

TYPICAL BACKBONE CABLE RISER DIAGRAM

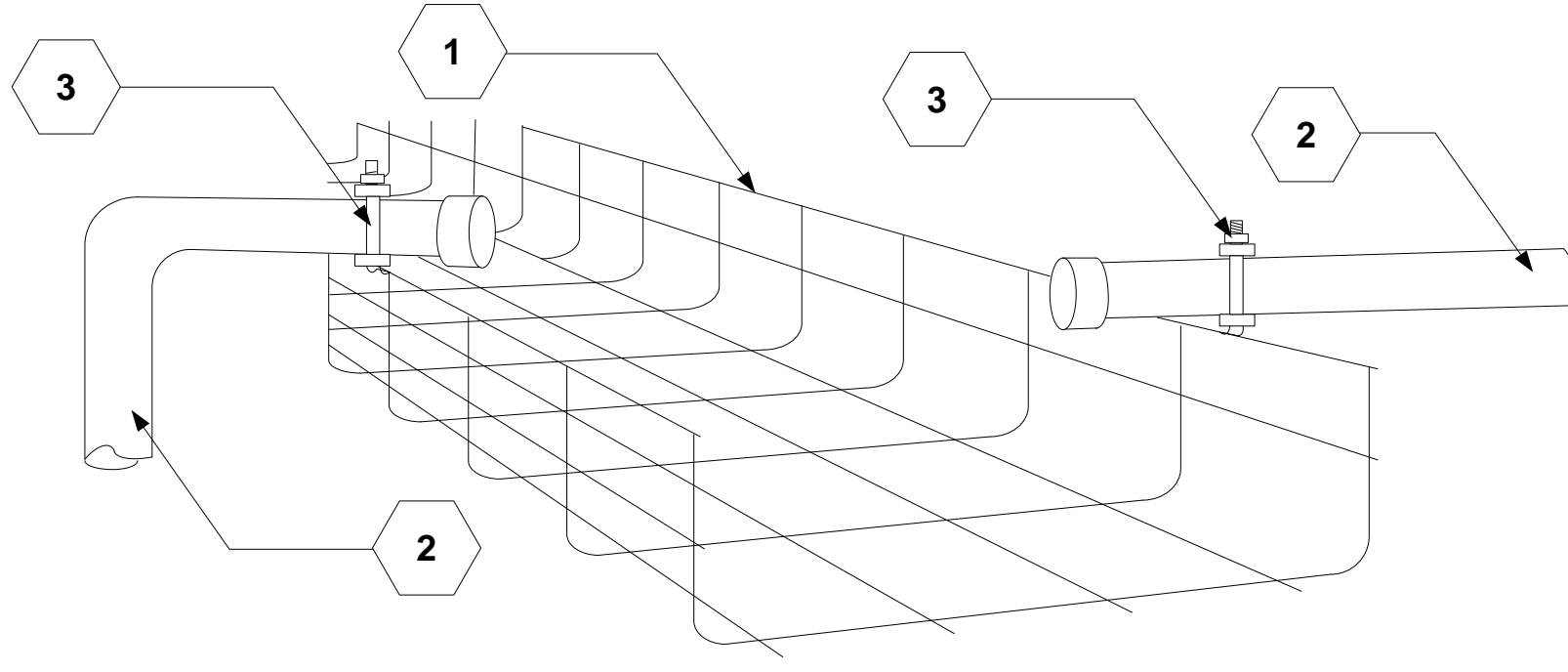

1 CONDUIT TO CABLE TRAY

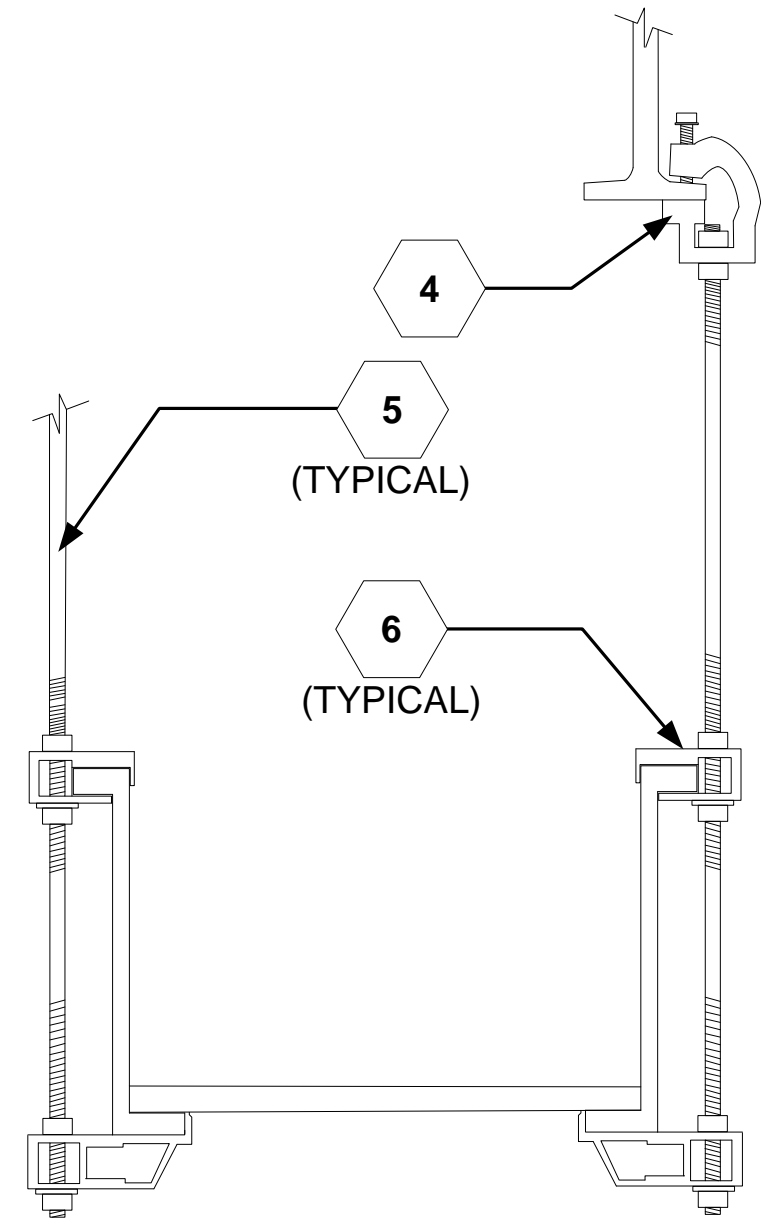

2 CABLE TRAY SUPPORT DIAGRAM

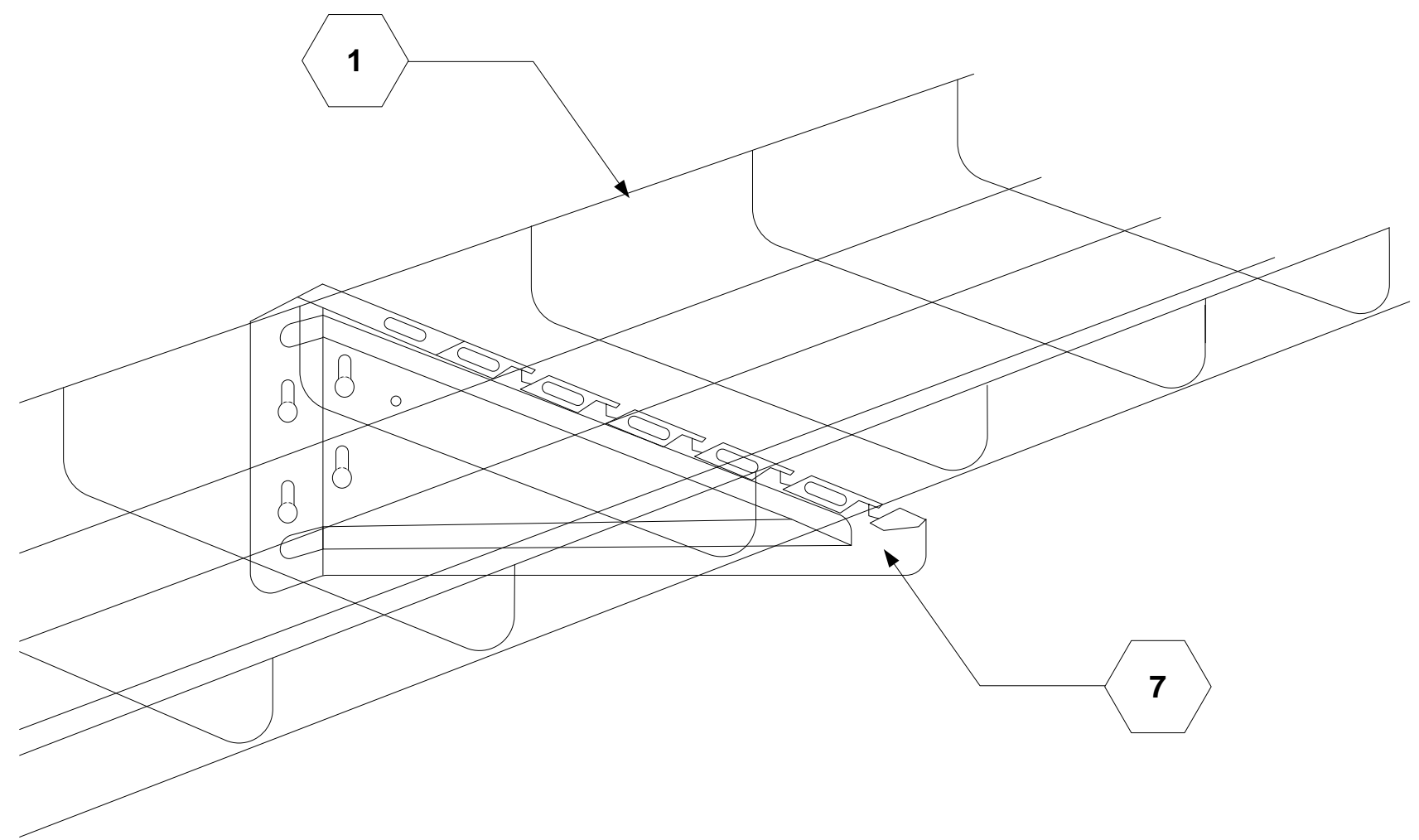

3 CABLE TRAY SUPPORT DIAGRAM

- SHEET KEY NOTES**
- 1 BASKET STYLE CABLE TRAY
 - 2 CONDUIT FROM OUTLET TO CABLE TRAY
 - 3 BOND CONDUIT TO CABLE TRAY
 - 4 BEAM CLAMP FOR CABLE TRAY SUPPORT
 - 5 THREADED ROD
 - 6 CABLE TRAY SUPPORTS
 - 7 TRIANGLE CABLE TRAY SUPPORT BRACKET



SYMBOL	REVISIONS DESCRIPTION	DATE	APPR.

DESIGNED BY: JOHN BABB
 DESIGNED BY: DEREK MITCHELL
 REVIEWED BY: ROBERT BABB
 USARMC G-6 RCDD

DATE: JUNE 2016

FOR OFFICIAL USE ONLY

USARMC G-6 NETWORKING AND INFRASTRUCTURE BRANCH INFRASTRUCTURE TEAM

U.S. ARMY RESERVE NETWORK ENTERPRISE CENTER INFRASTRUCTURE TECHNICAL CRITERIA DIAGRAM AND DETAILS

B.36

TYPICAL CABLE TRAY ENLARGED DIAGRAMS

SHEET KEY NOTES

- 1 CATEGORY 6 RATED J-HOOK
- 2 WIRE MESH CABLE TRAY
- 3 CONDUIT STUB-OUT TO ACCESSIBLE CEILING SPACE
- 4 J-HOOK BEAM CLAMP
- 5 OUTLET BOX
- 6 LOW VOLTAGE MOUNTING BRACKET
- 7 CATEGORY 6 CABLE



SYMBOL	REVISIONS DESCRIPTION	DATE	APPR.

DESIGNED BY: JOHN BABB	DATE: JUNE 2016
DESIGNED BY: DEREK MITCHELL	FOR OFFICIAL USE ONLY
REVIEWED BY: ROBERT BABB USARC G-6 RCDD	

USARC G-6
NETWORKING AND
INFRASTRUCTURE
BRANCH
INFRASTRUCTURE
TEAM

U.S. ARMY RESERVE
NETWORK ENTERPRISE CENTER
INFRASTRUCTURE
TECHNICAL CRITERIA
DIAGRAM AND DETAILS

B.37

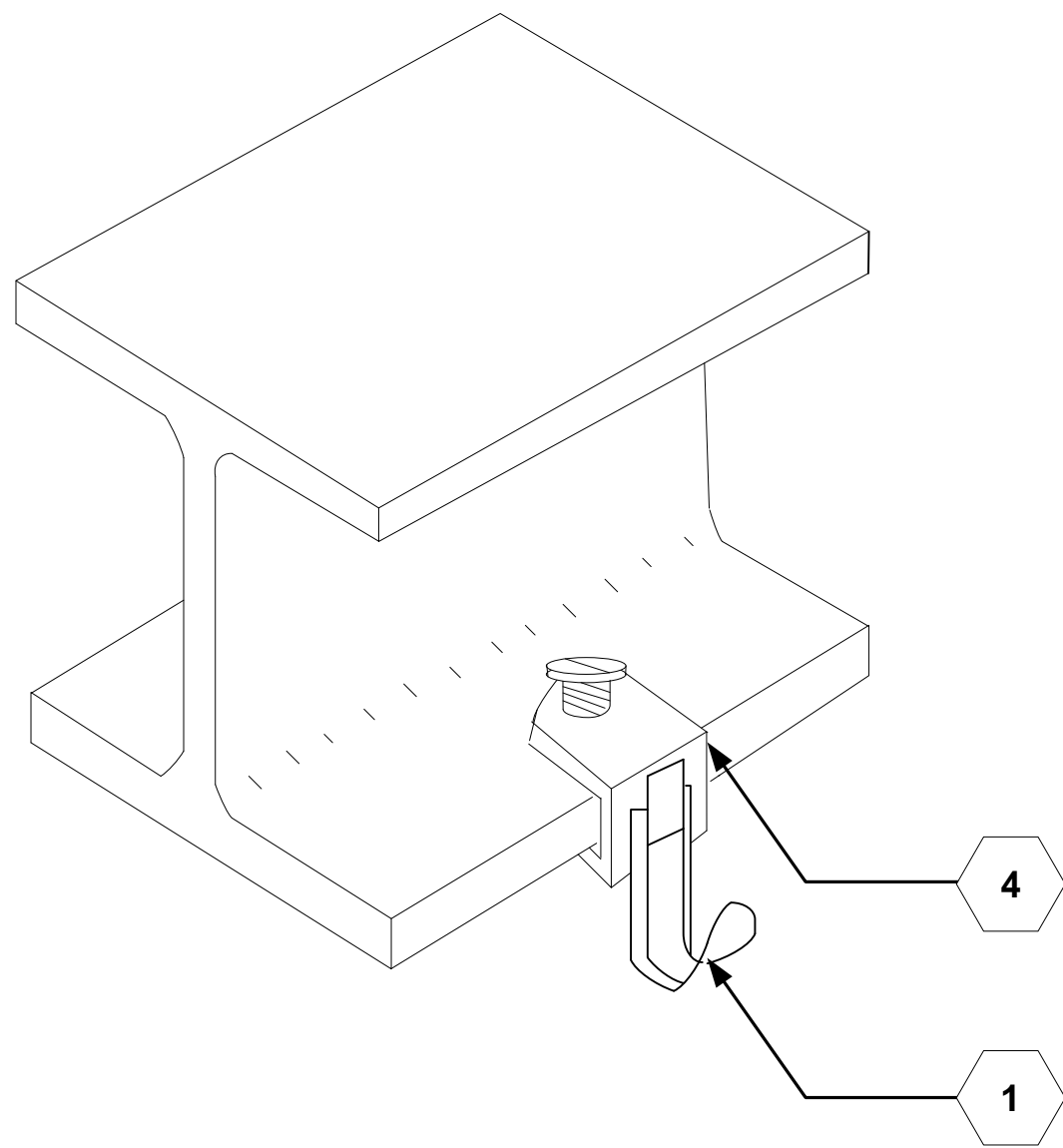

1 J-HOOK TO BUILDING STEEL SUPPORT

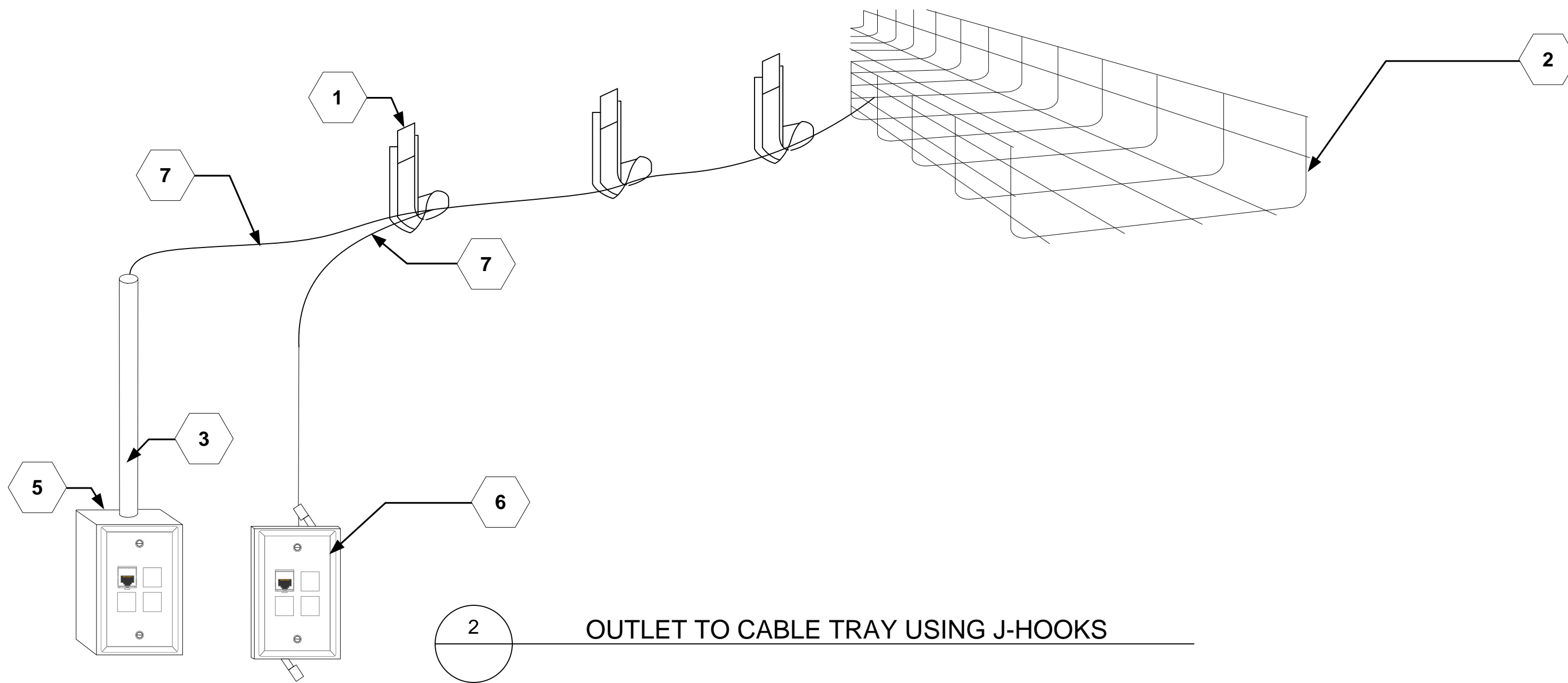

2 OUTLET TO CABLE TRAY USING J-HOOKS

TYPICAL J-HOOK ENLARGED DIAGRAMS

SHEET KEY NOTES

- 1 CATEGORY 6 CONSOLIDATION POINT
- 2 FLOOR-BOX
- 3 UL LISTED NEMA ENCLOSURE
- 4 UL LISTED FIRE-RATED BARRIER
- 5 CATEGORY 6 WET-RATED HORIZONTAL CABLE
- 6 CATEGORY 6 PLENUM RATED HORIZONTAL CABLE
- 7 CONDUIT



SYMBOL	REVISIONS DESCRIPTION	DATE	APPR.

DESIGNED BY: JOHN BABB	DATE: JUNE 2016	FOR OFFICIAL USE ONLY
DESIGNED BY: DEREK MITCHELL		
REVIEWED BY: ROBERT BABB USARC G-6 RCDD		

USARC G-6
NETWORKING AND
INFRASTRUCTURE
BRANCH
INFRASTRUCTURE
TEAM

U.S. ARMY RESERVE
NETWORK ENTERPRISE CENTER
INFRASTRUCTURE
TECHNICAL CRITERIA
DIAGRAM AND DETAILS

B.38

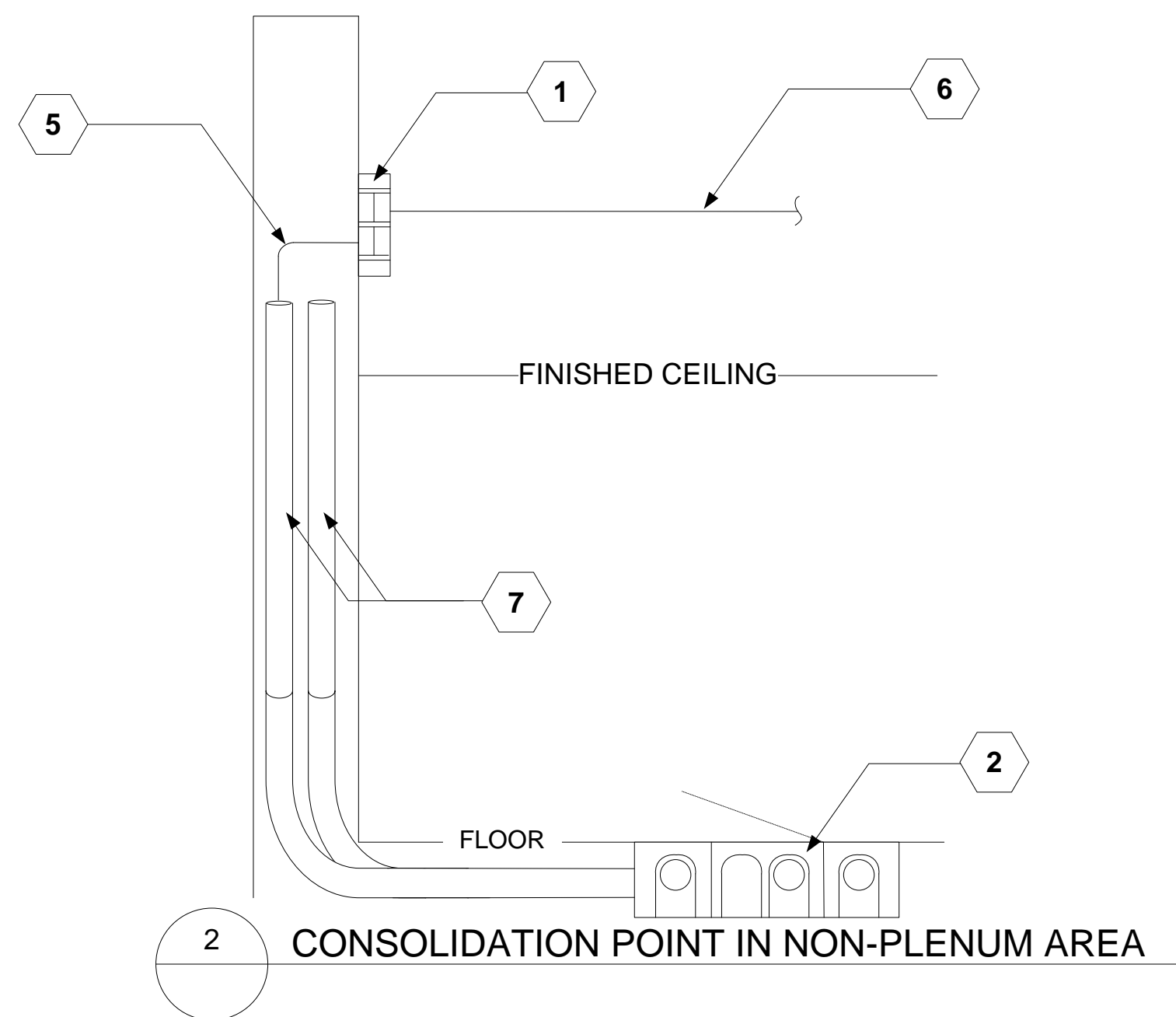
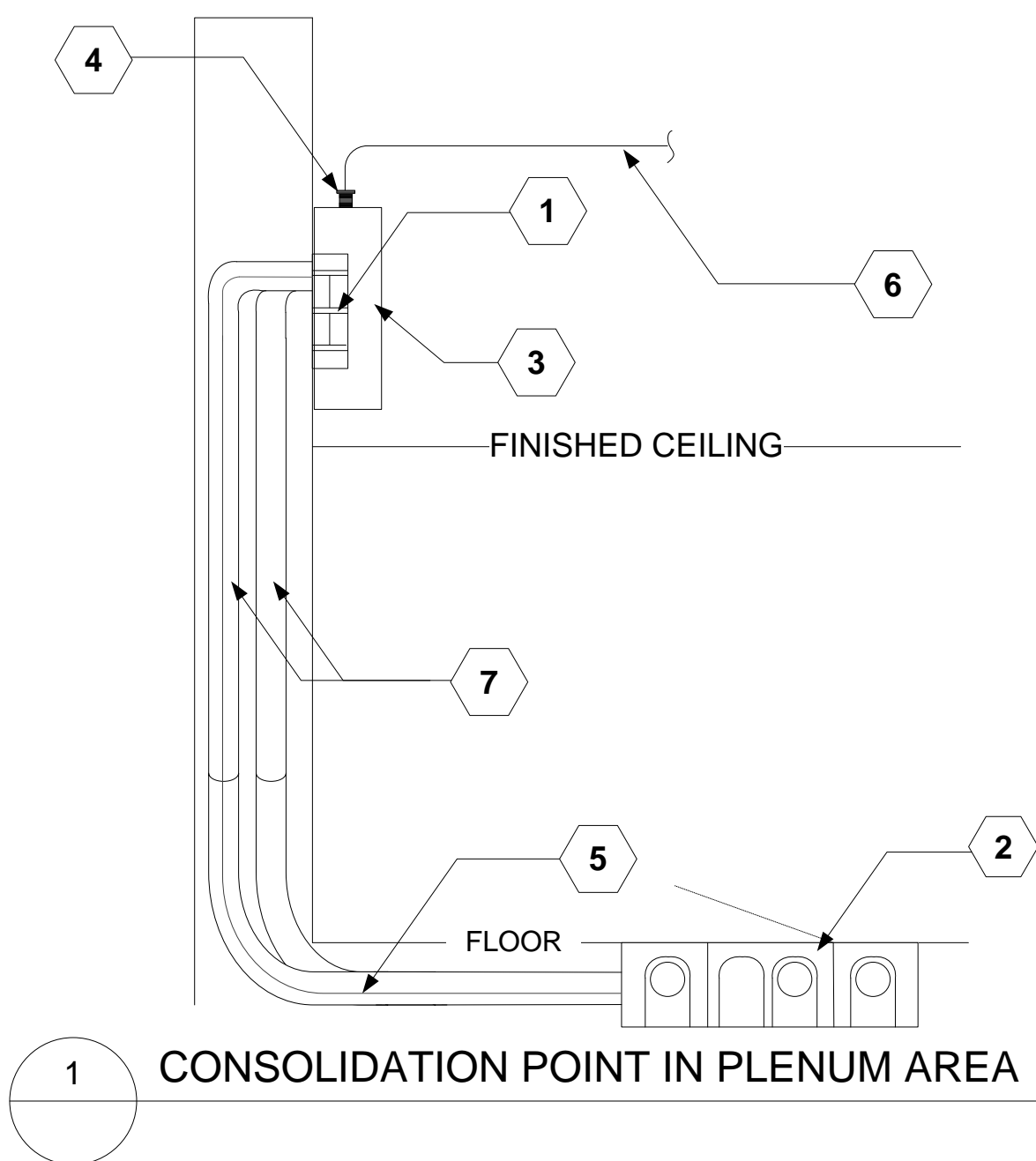

TYPICAL CONSOLIDATION POINT AND FLOOR BOX DETAIL

SHEET KEY NOTES

- 1 FLEXIBLE METAL CONDUIT FROM FLOOR BOX TO ACOUSTIC PANEL RACEWAY
- 2 FURNITURE ACOUSTIC RACEWAY
- 3 FLOOR BOX OR POKE-THRU
- 4 WALL MOUNTED JUNCTION BOX



SYMBOL	REVISIONS DESCRIPTION	DATE	APPR.

DESIGNED BY: JOHN BABB	DATE: JUNE 2016
DESIGNED BY: DEREK MITCHELL	FOR OFFICIAL USE ONLY
REVIEWED BY: ROBERT BABB	
USARC G-6 RCDD	

USARC G-6
NETWORKING AND
INFRASTRUCTURE
BRANCH
INFRASTRUCTURE
TEAM

U.S. ARMY RESERVE
NETWORK ENTERPRISE CENTER
INFRASTRUCTURE
TECHNICAL CRITERIA
DIAGRAM AND DETAILS

B.39

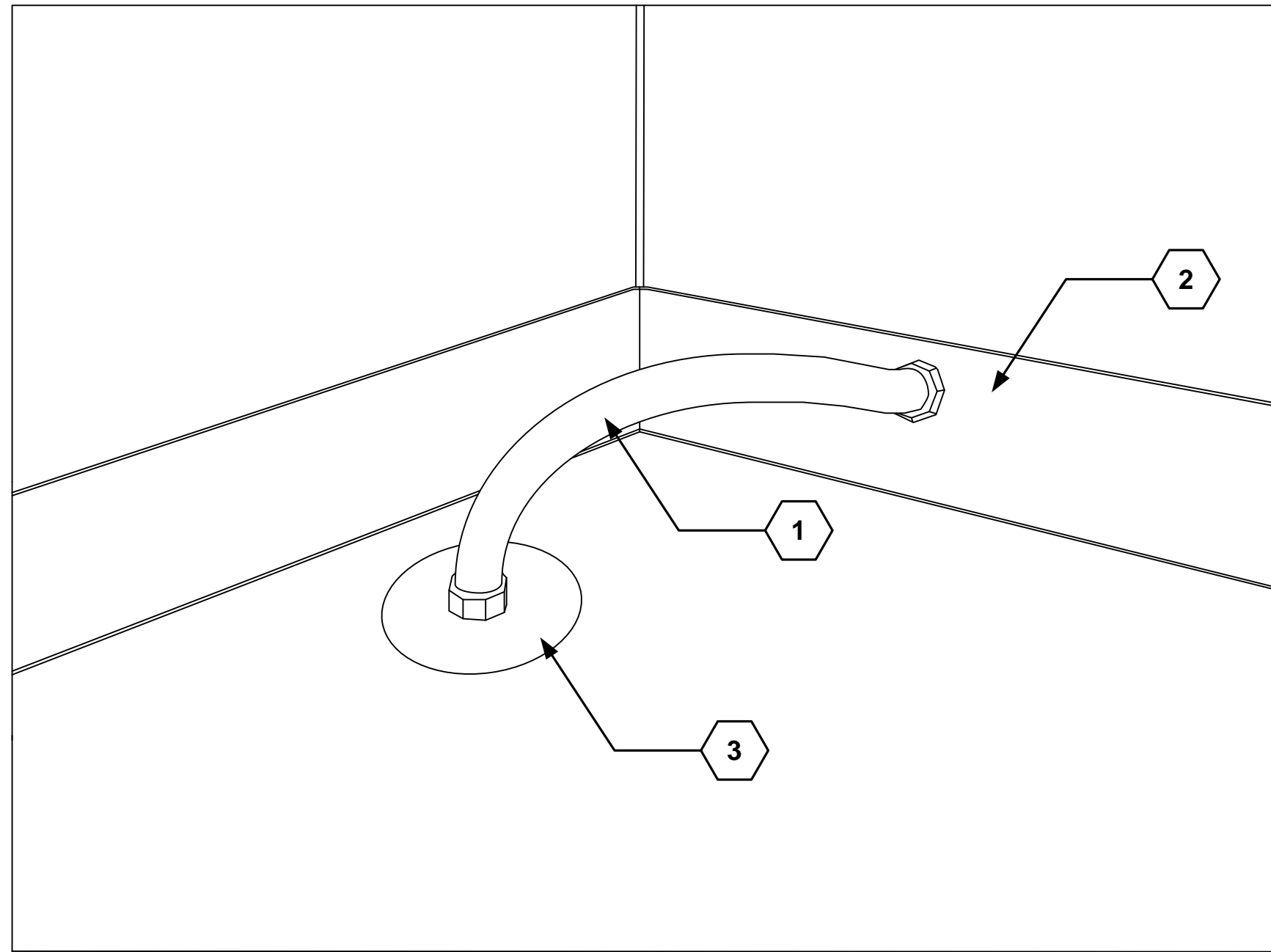

1 WHIP FROM FLOOR BOX/POKE-THRU TO KICK PLATE

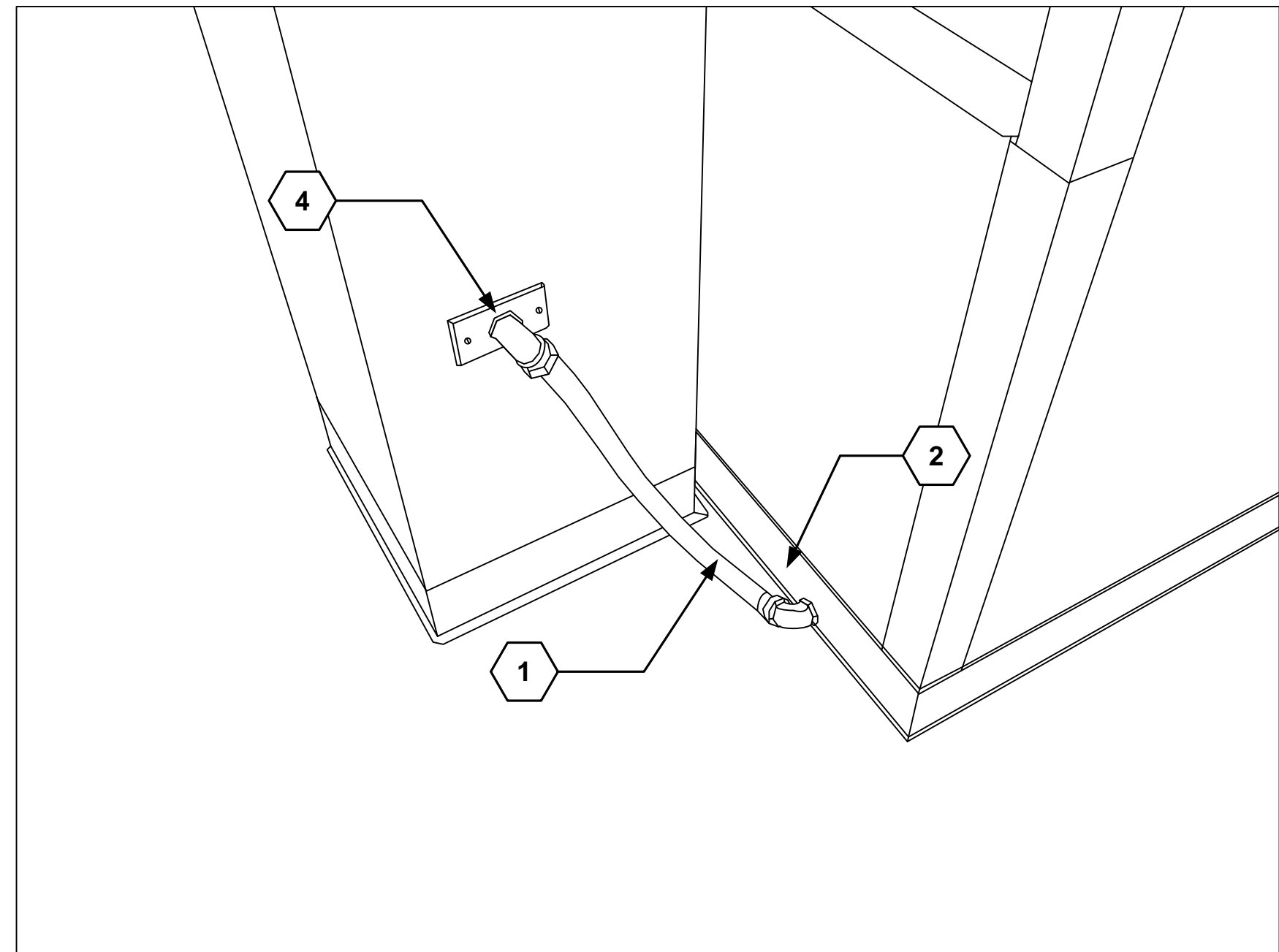

2 WHIP FROM JUNCTION BOX TO KICK PLATE

TYPICAL FURNITURE WHIP DETAILS

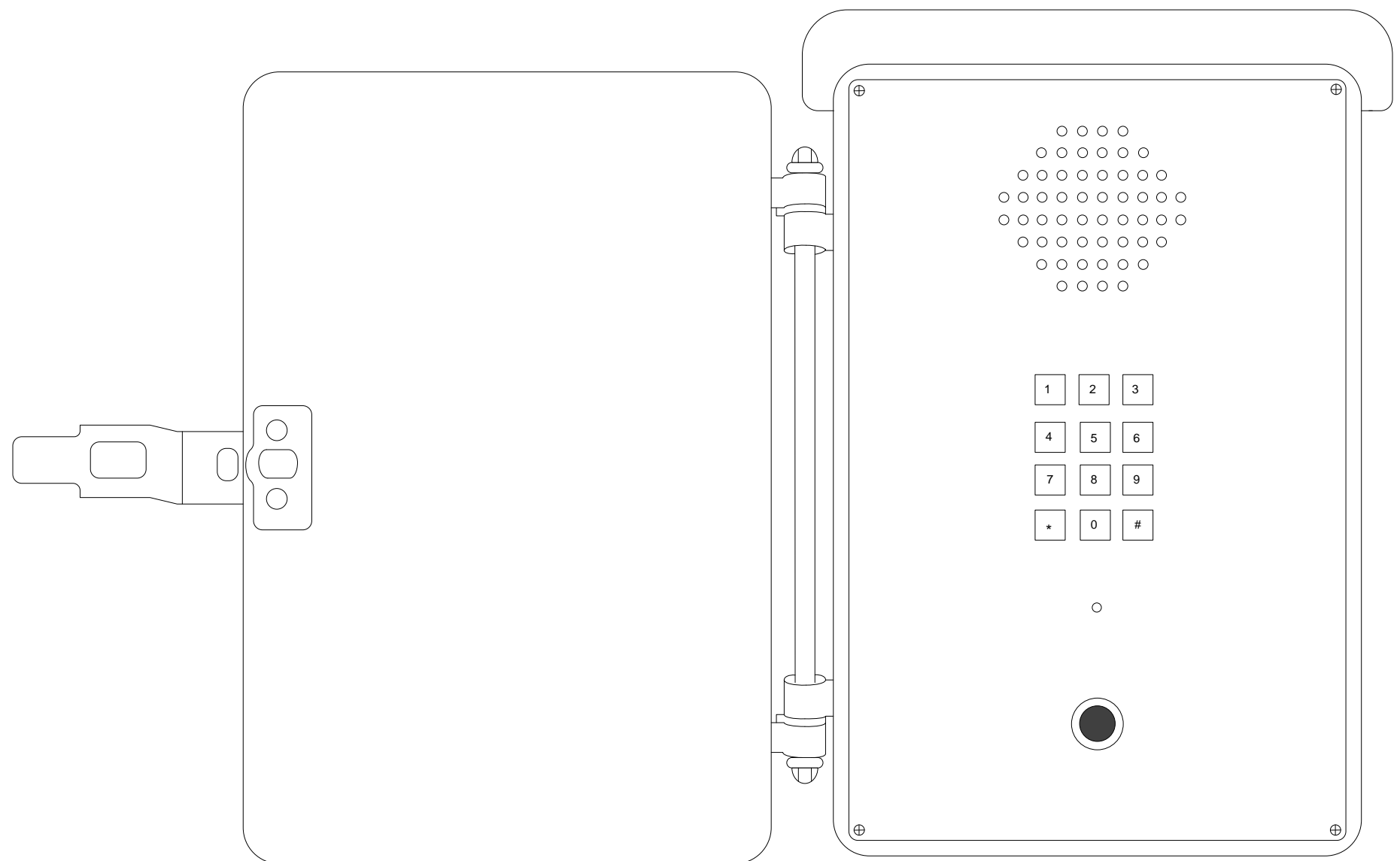

1

CALLBOX DETAIL

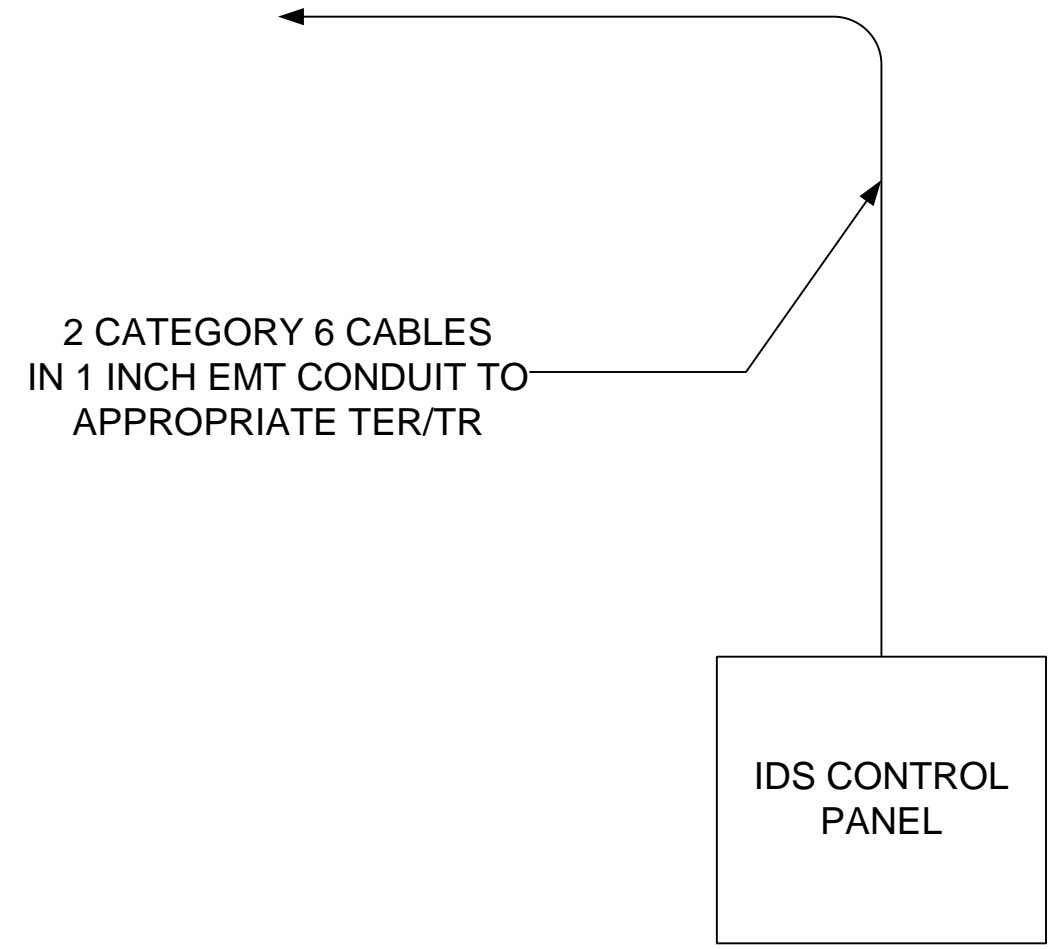

2

IDS CONTROL PANEL DETAIL



SYMBOL	REVISIONS DESCRIPTION	DATE	APPR.

DESIGNED BY:
JOHN BABB

DESIGNED BY:
DEREK MITCHELL

REVIEWED BY:
ROBERT BABB
USARC G-6 RCDD

DATE:
JUNE 2016

FOR OFFICIAL USE ONLY

USARC G-6 NETWORKING AND INFRASTRUCTURE BRANCH INFRASTRUCTURE TEAM

U.S. ARMY RESERVE NETWORK ENTERPRISE CENTER INFRASTRUCTURE TECHNICAL CRITERIA DIAGRAM AND DETAILS

B.40

TYPICAL EXTERIOR CALL BOX ENLARGED DETAIL AND ARMS VAULT IDS DETAIL

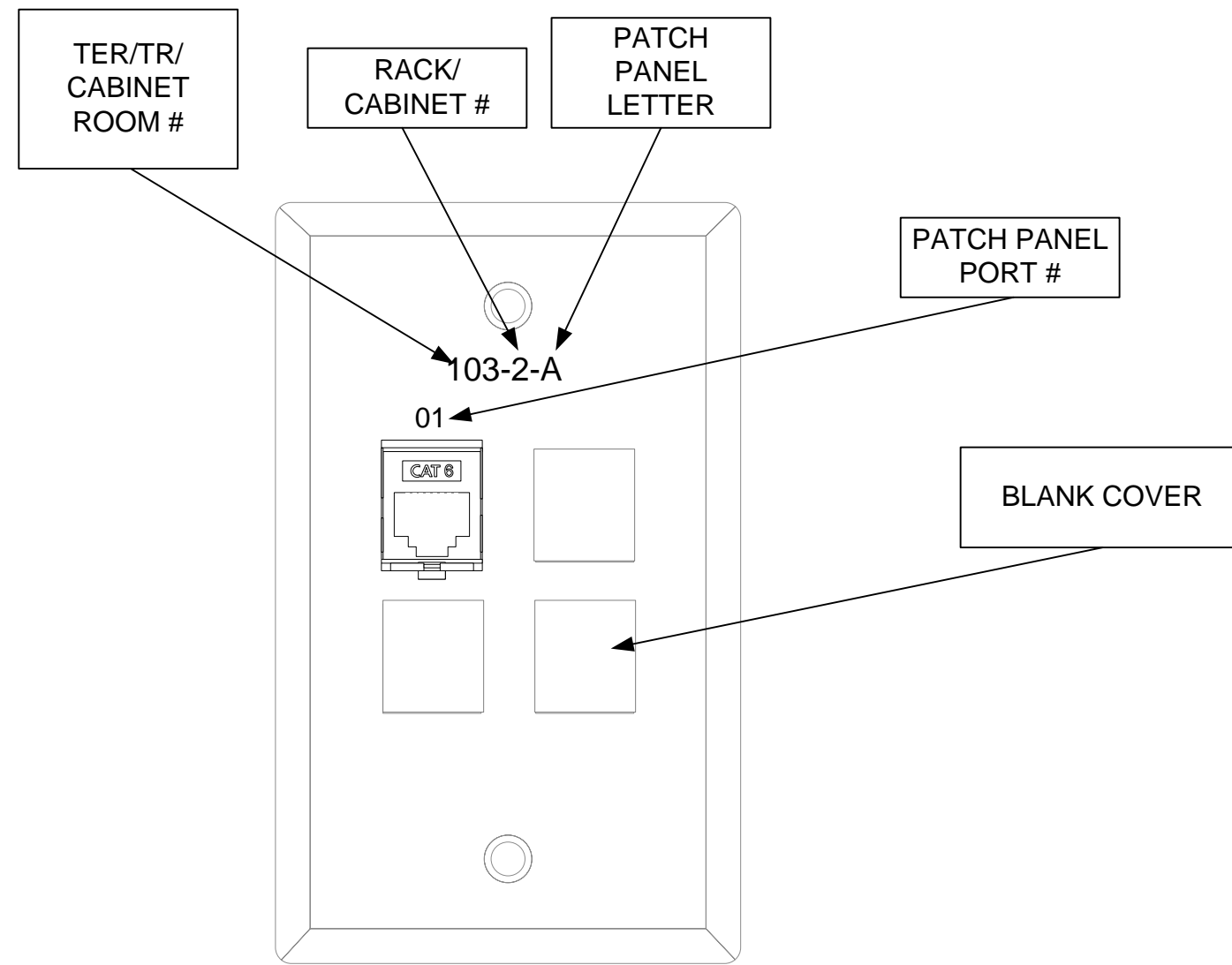

1 WALL ICT OUTLET LAYOUT AND LABELING SCHEME

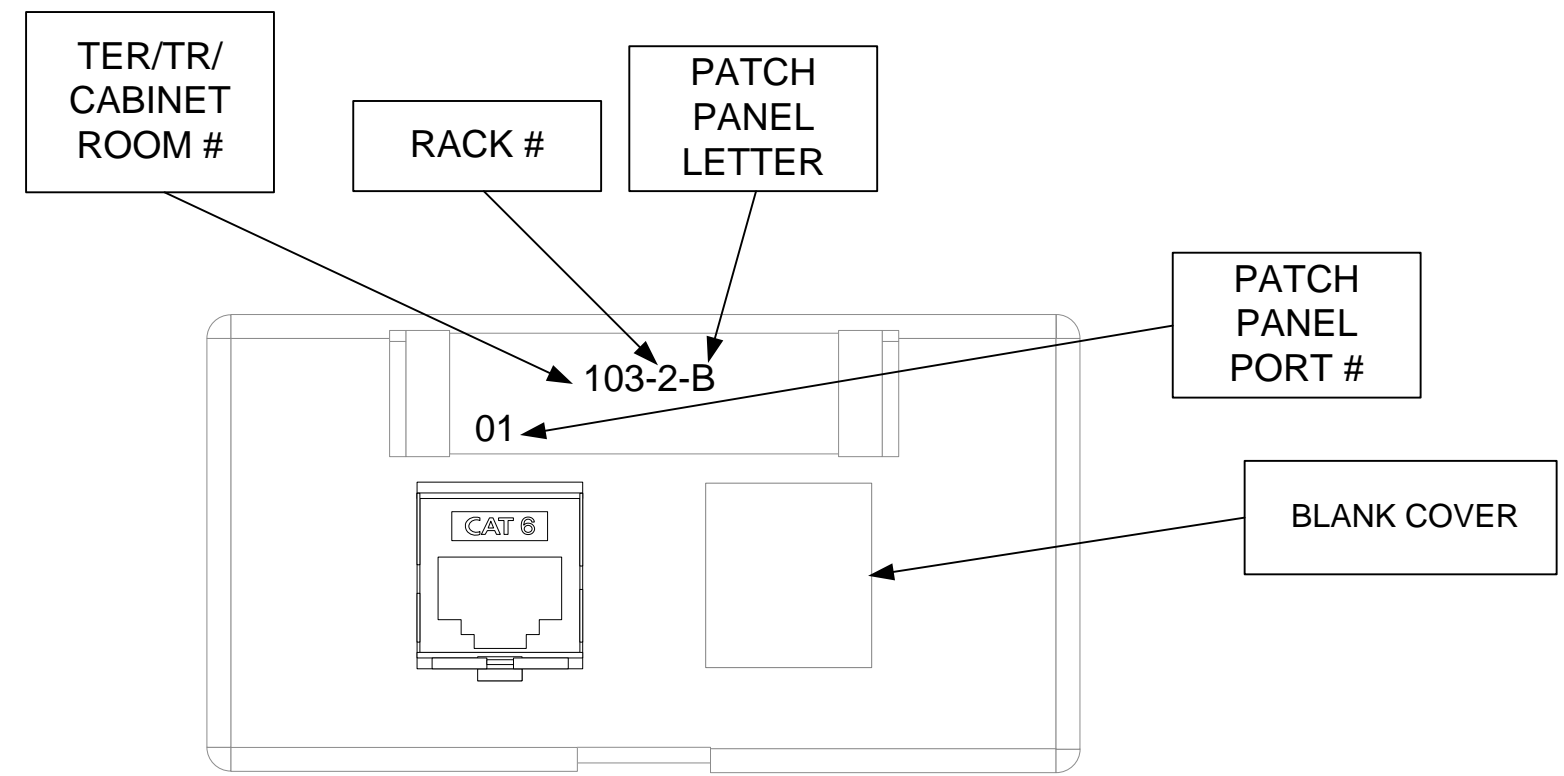

2 FURNITURE ICT OUTLET LAYOUT AND LABELING SCHEME

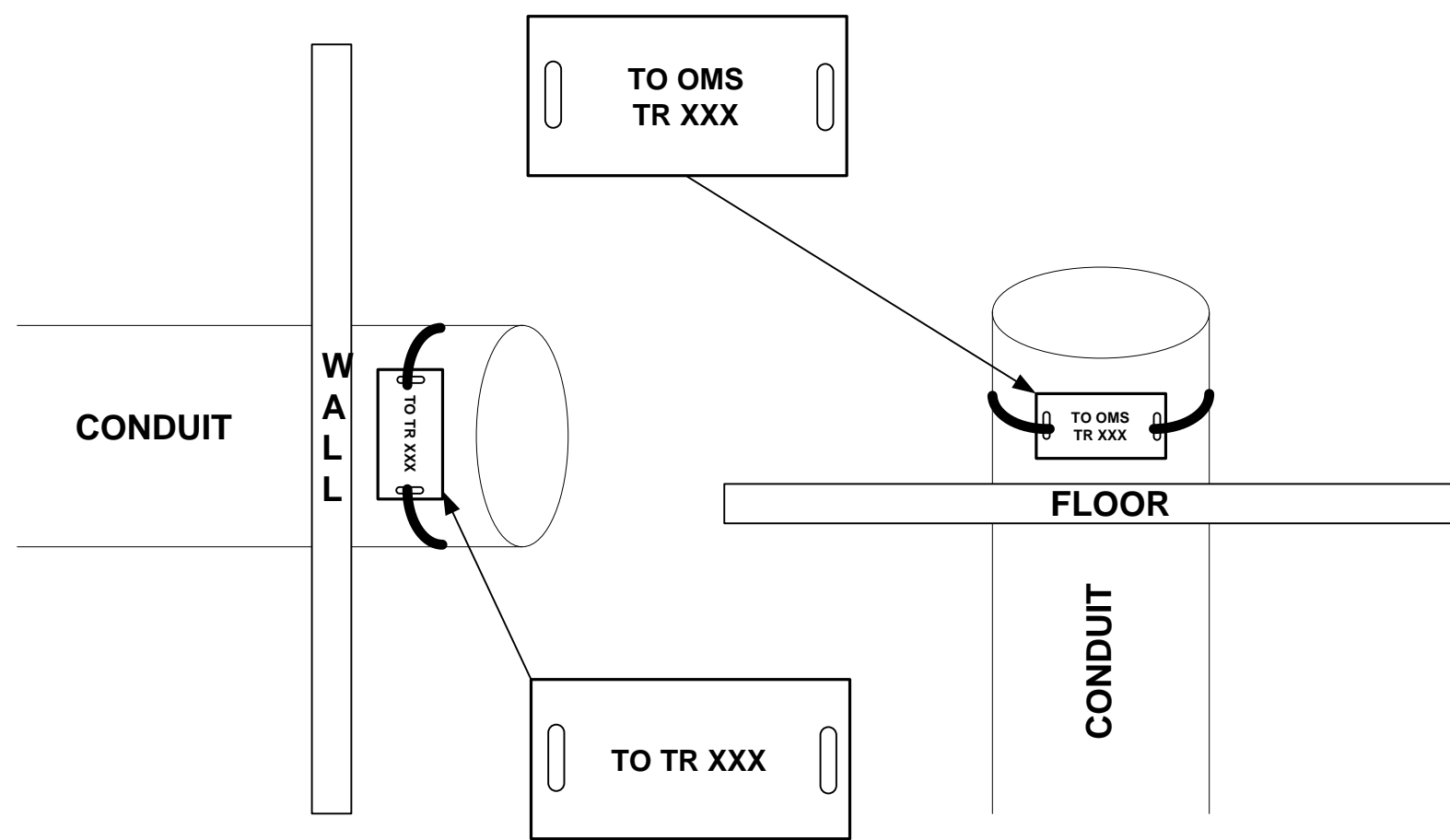

3 CONDUIT LABELS

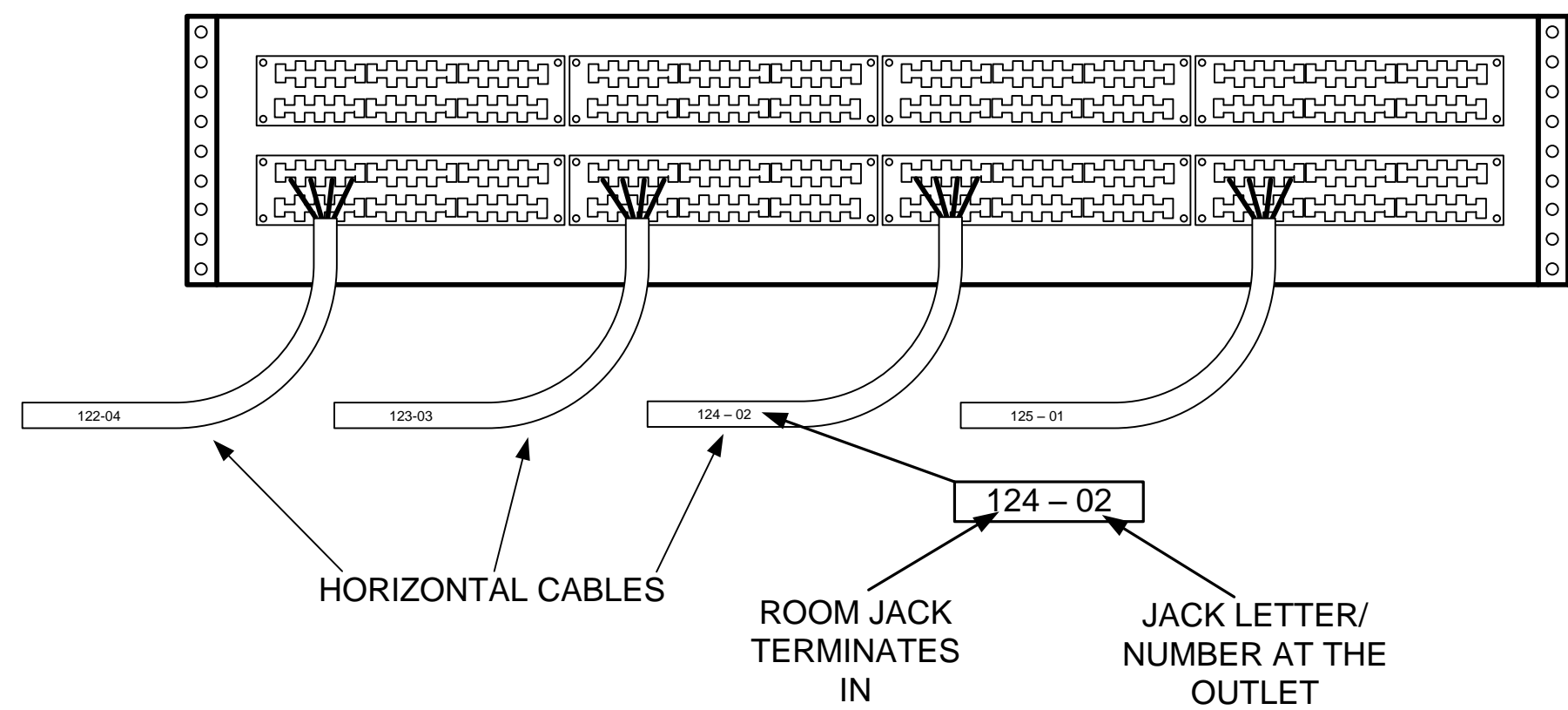

4 CATEGORY 6 PATCH PANEL REAR LABELING SCHEME

TYPICAL LAYOUT AND LABELING DIAGRAMS



SYMBOL	REVISIONS	DATE	APPR.
	DESCRIPTION		

DESIGNED BY: JOHN BABB
 DESIGNED BY: DEREK MITCHELL
 REVIEWED BY: ROBERT BABB
 USARC G-6 RCDD

DATE: JUNE 2016
 FOR OFFICIAL USE ONLY

USARC G-6 NETWORKING AND INFRASTRUCTURE BRANCH INFRASTRUCTURE TEAM

U.S. ARMY RESERVE NETWORK ENTERPRISE CENTER INFRASTRUCTURE TECHNICAL CRITERIA DIAGRAM AND DETAILS

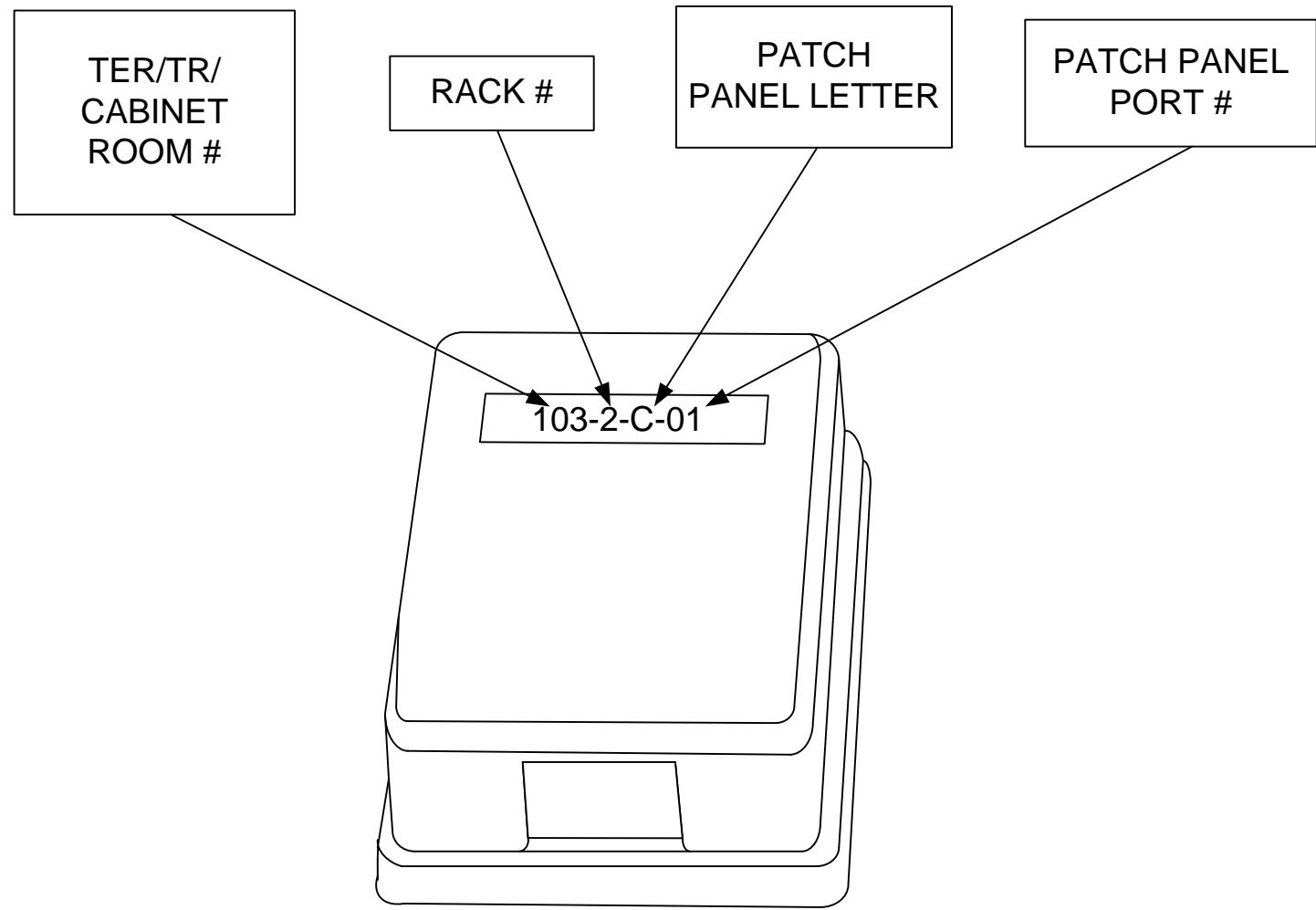

1 ABOVE CEILING WAP OUTLET LABELING SCHEME

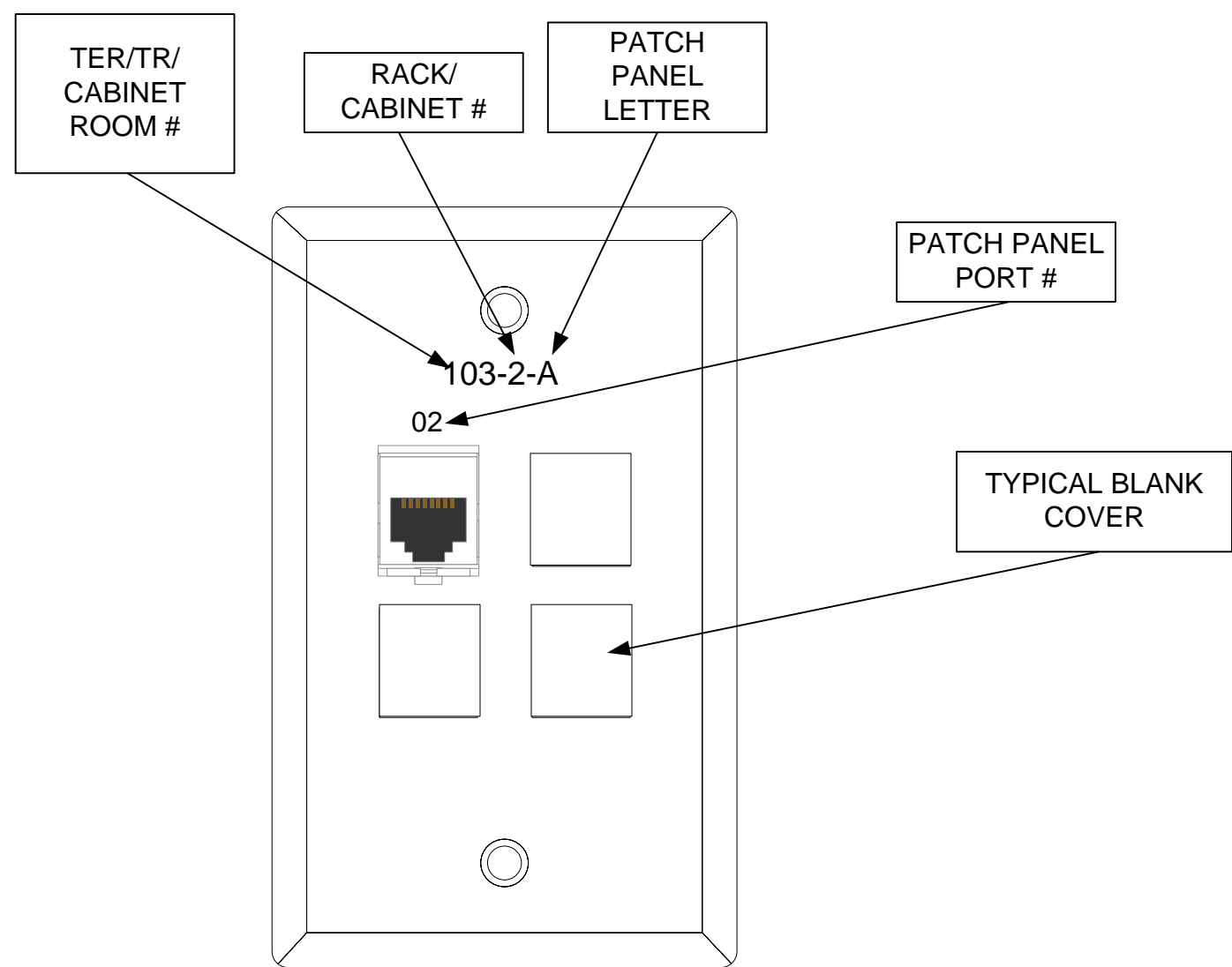

2 BELOW CEILING FLUSH MOUNTED WAP OUTLET LABELING SCHEME

NOTE: WAP OUTLET LABEL MUST BE LOCATED ON THE CEILING GRID AS CLOSE AS POSSIBLE TO THE LOCATION OF THE WAP OUTLET

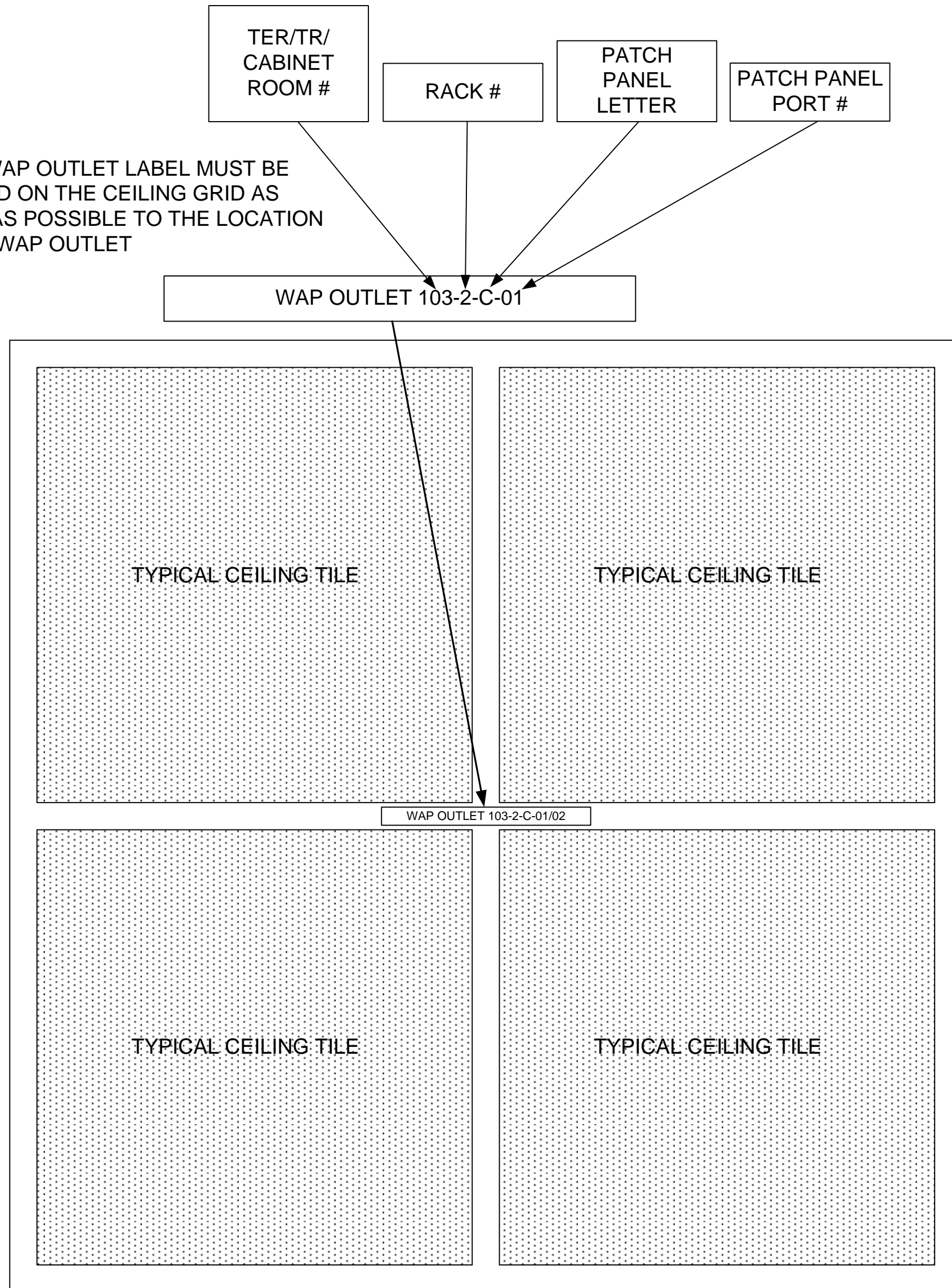

3 CEILING GRID LABEL FOR ABOVE CEILING WAP

TYPICAL LABELING DIAGRAMS



REVISIONS	DATE	APPR.
SYMBOL		
DESCRIPTION		

DESIGNED BY:	JOHN BABB
DESIGNED BY:	DEREK MITCHELL
REVIEWED BY:	ROBERT BABB
	USARC G-6 RCDD

USARC G-6
NETWORKING AND
INFRASTRUCTURE
BRANCH
INFRASTRUCTURE
TEAM

U.S. ARMY RESERVE
NETWORK ENTERPRISE CENTER
INFRASTRUCTURE
TECHNICAL CRITERIA
DIAGRAM AND DETAILS

B.42

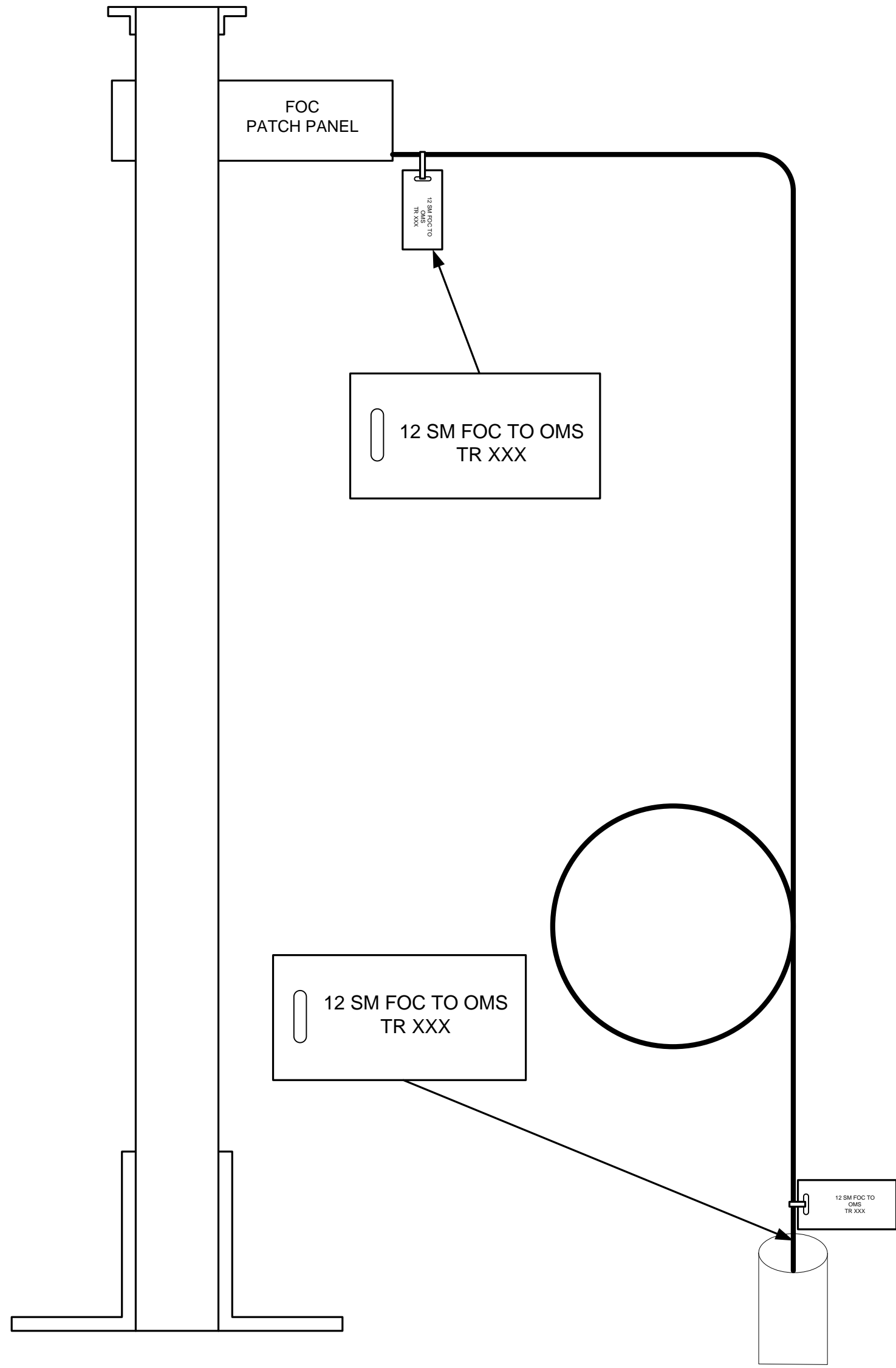

1 FOC CABLE AND RACK MOUNTED FOC PATCH PANEL LABELS

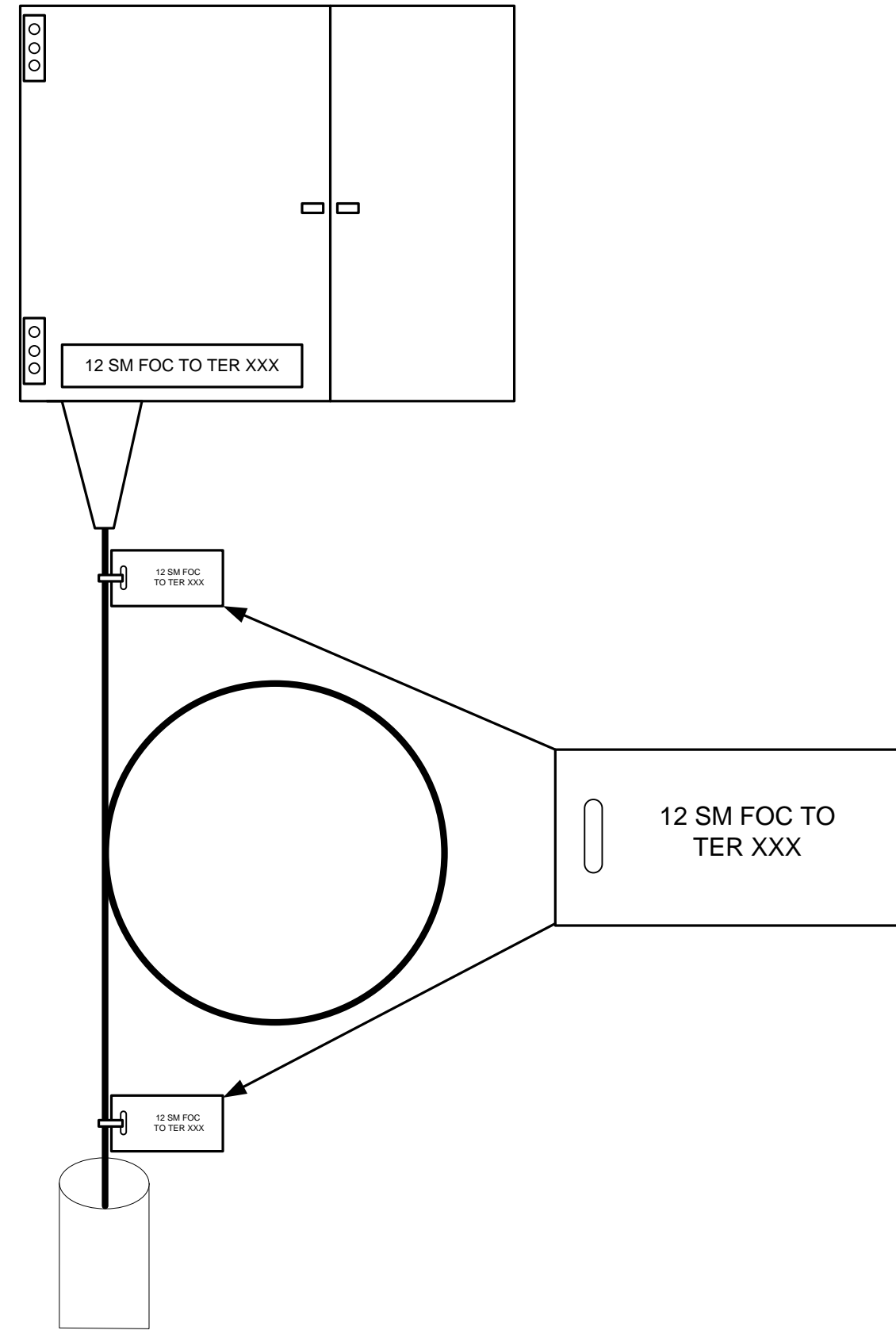

2 FOC CABLE AND WALL MOUNTED FOC PATCH PANEL LABELS

TYPICAL LABELING DIAGRAMS



SYMBOL	REVISIONS DESCRIPTION	DATE	APPR.

DESIGNED BY: JOHN BABB
 DESIGNED BY: DEREK MITCHELL
 REVIEWED BY: ROBERT BABB
 USARMC G-6 RCDD

DATE: JUNE 2016

FOR OFFICIAL USE ONLY

USARMC G-6 NETWORKING AND INFRASTRUCTURE BRANCH INFRASTRUCTURE TEAM

U.S. ARMY RESERVE NETWORK ENTERPRISE CENTER INFRASTRUCTURE TECHNICAL CRITERIA DIAGRAM AND DETAILS

B.43



SYMBOL	REVISIONS	DATE	APPR.
	DESCRIPTION		

DESIGNED BY: JOHN BABB	DATE: JUNE 2016	FOR OFFICIAL USE ONLY
DESIGNED BY: DEREK MITCHELL		
REVIEWED BY: ROBERT BABB USARC G-6 RCDD		

USARC G-6
NETWORKING AND
INFRASTRUCTURE
BRANCH
INFRASTRUCTURE
TEAM

U.S. ARMY RESERVE
NETWORK ENTERPRISE CENTER
INFRASTRUCTURE
TECHNICAL CRITERIA
DIAGRAM AND DETAILS

B.44

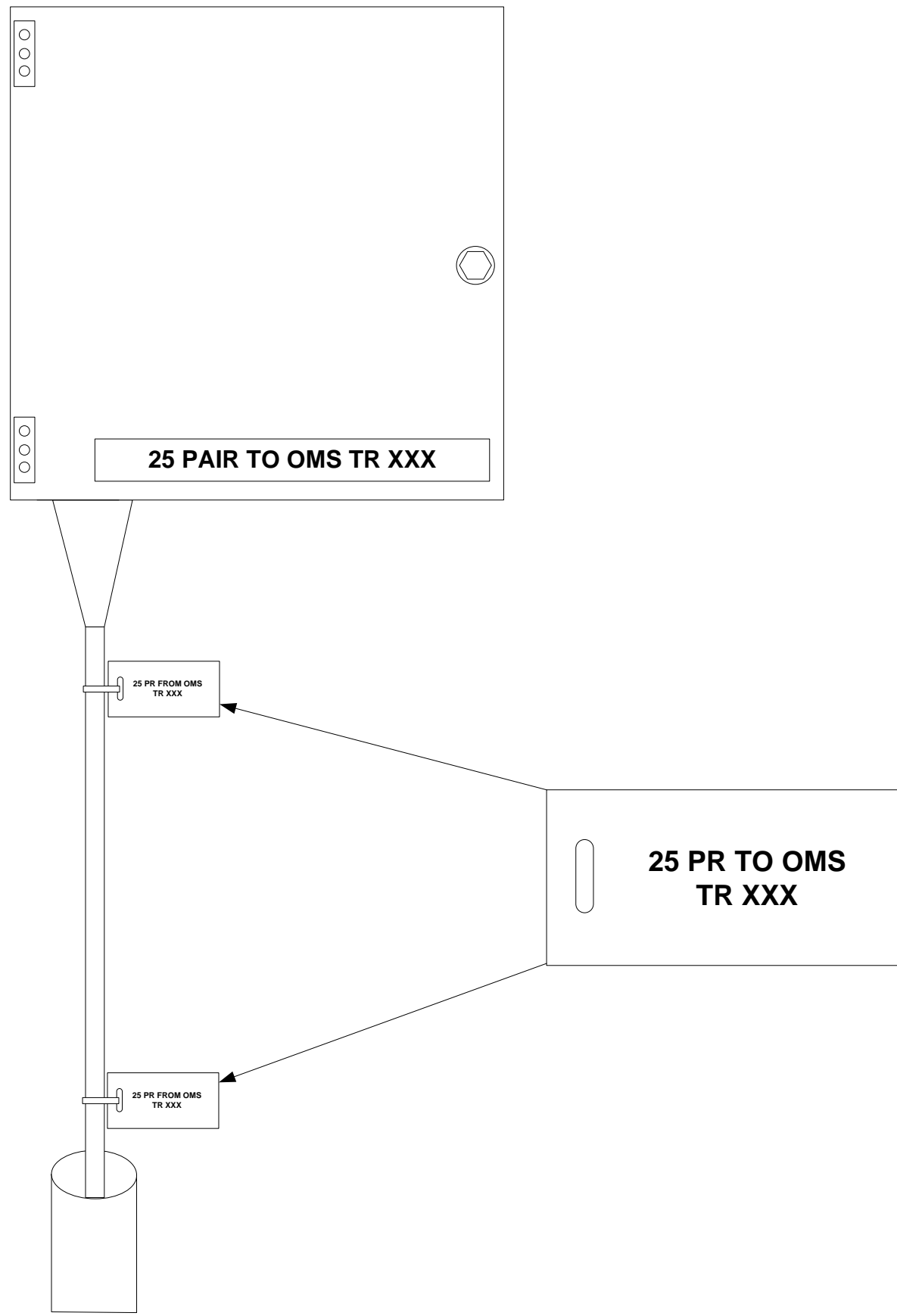

1 COPPER BACKBONE CABLE AND BUILDING ENTERANCE PROTECTOR LABLES

TYPICAL LABELING DIAGRAMS

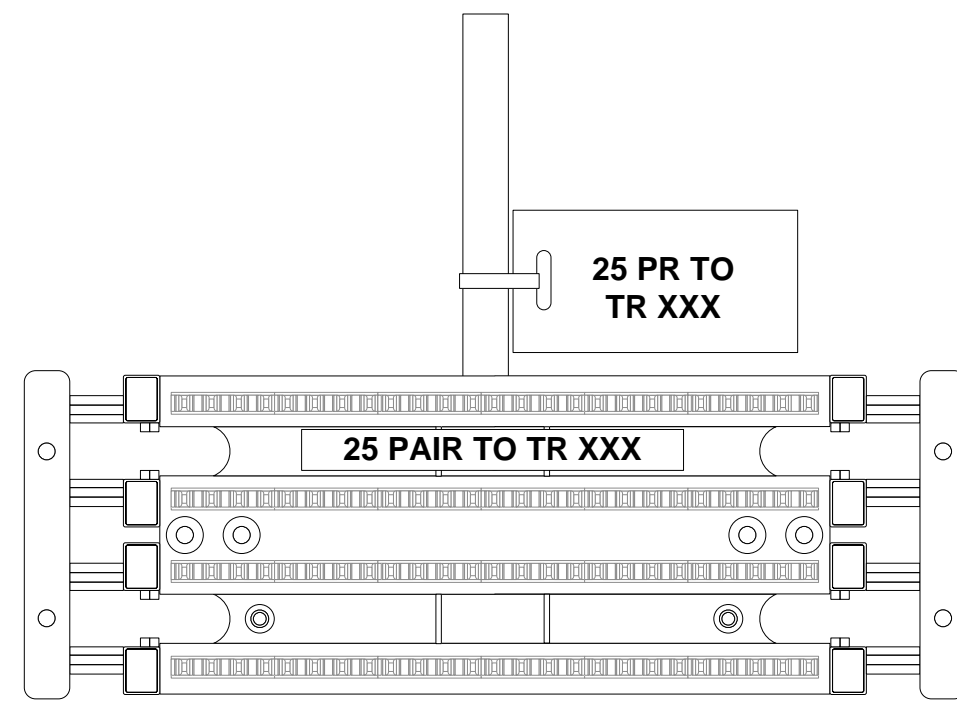

2 COPPER BACKBONE CABLE AND 110 BLOCK LABLES

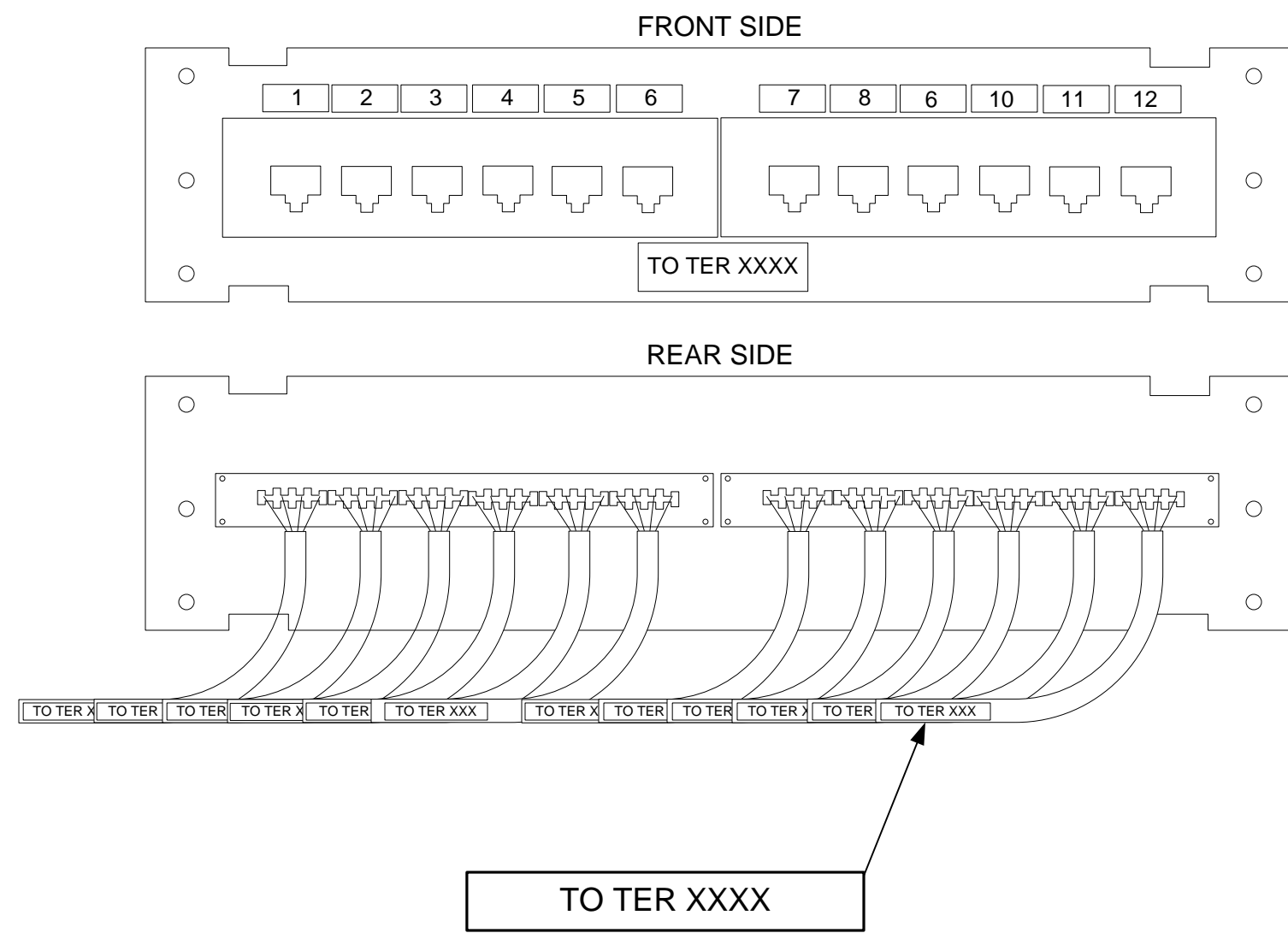

2 EF WALL MOUNTED 12 PORT PATCH PANEL LABELING DIAGRAM



ENLARGED 12 PORT PATCH PANEL LABELING DIAGRAM

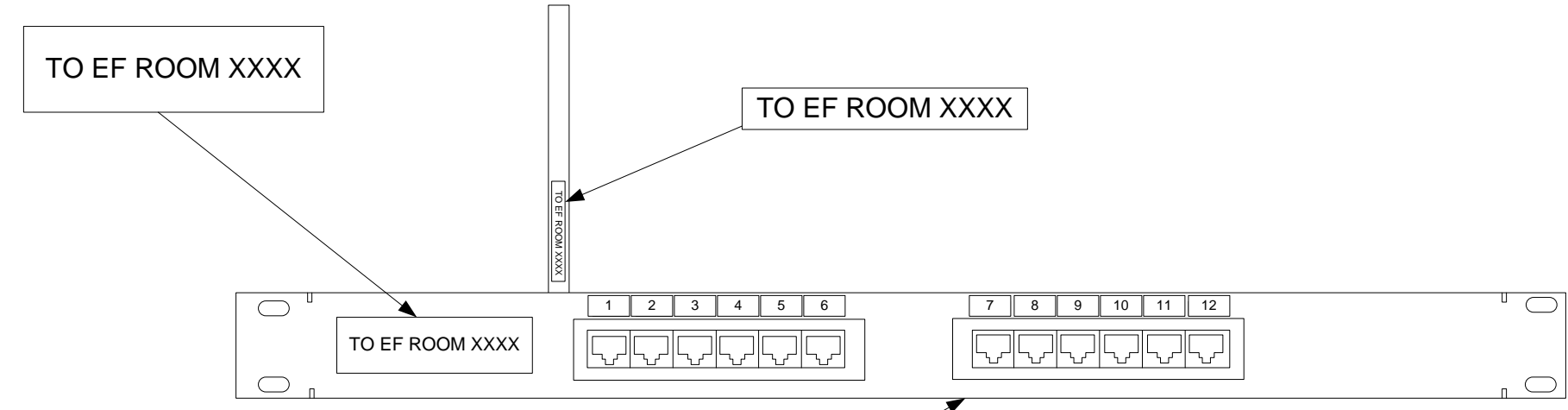

ENLARGED FOC PATCH PANEL DIAGRAM

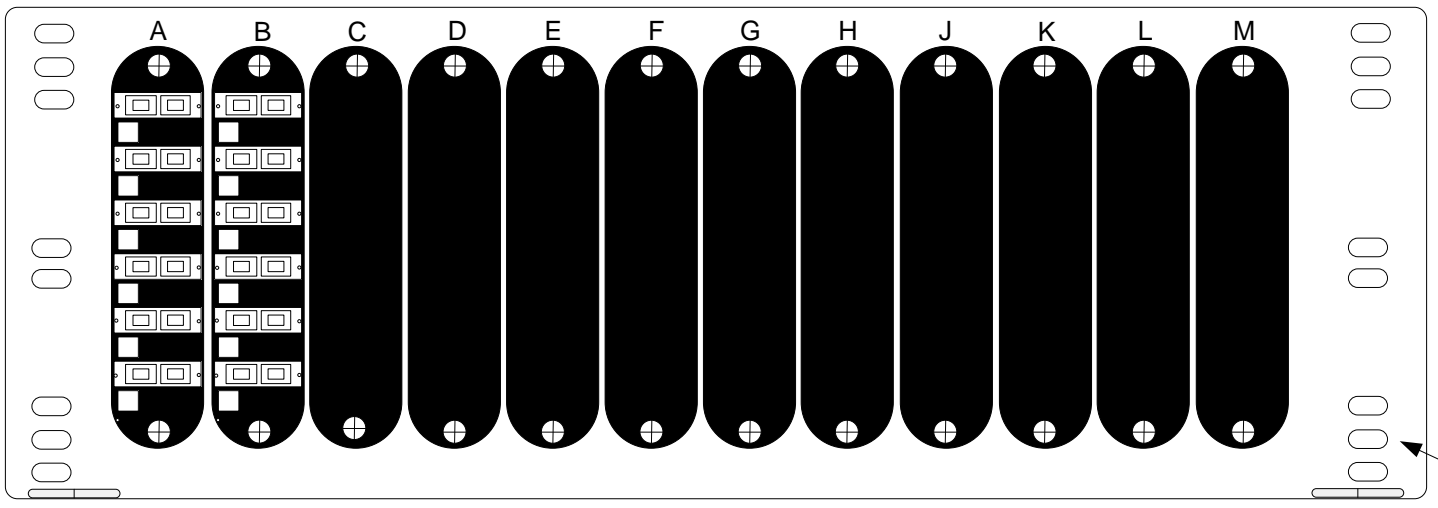

A: 1-12 SM FOC to TR XXX

B: 1-12 SM FOC to OMS TR XXX

FOC PATCH PANEL OUTSIDE OF FRONT COVER

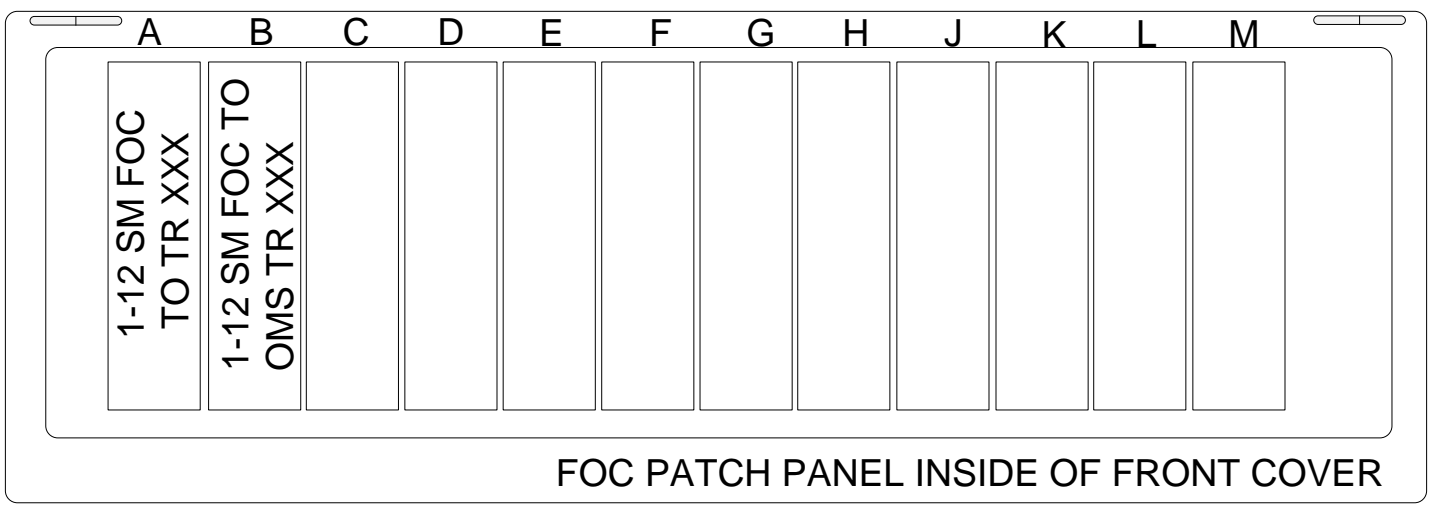

FOC PATCH PANEL INSIDE OF FRONT COVER

ICT RACK FRONT ICT RACK REAR

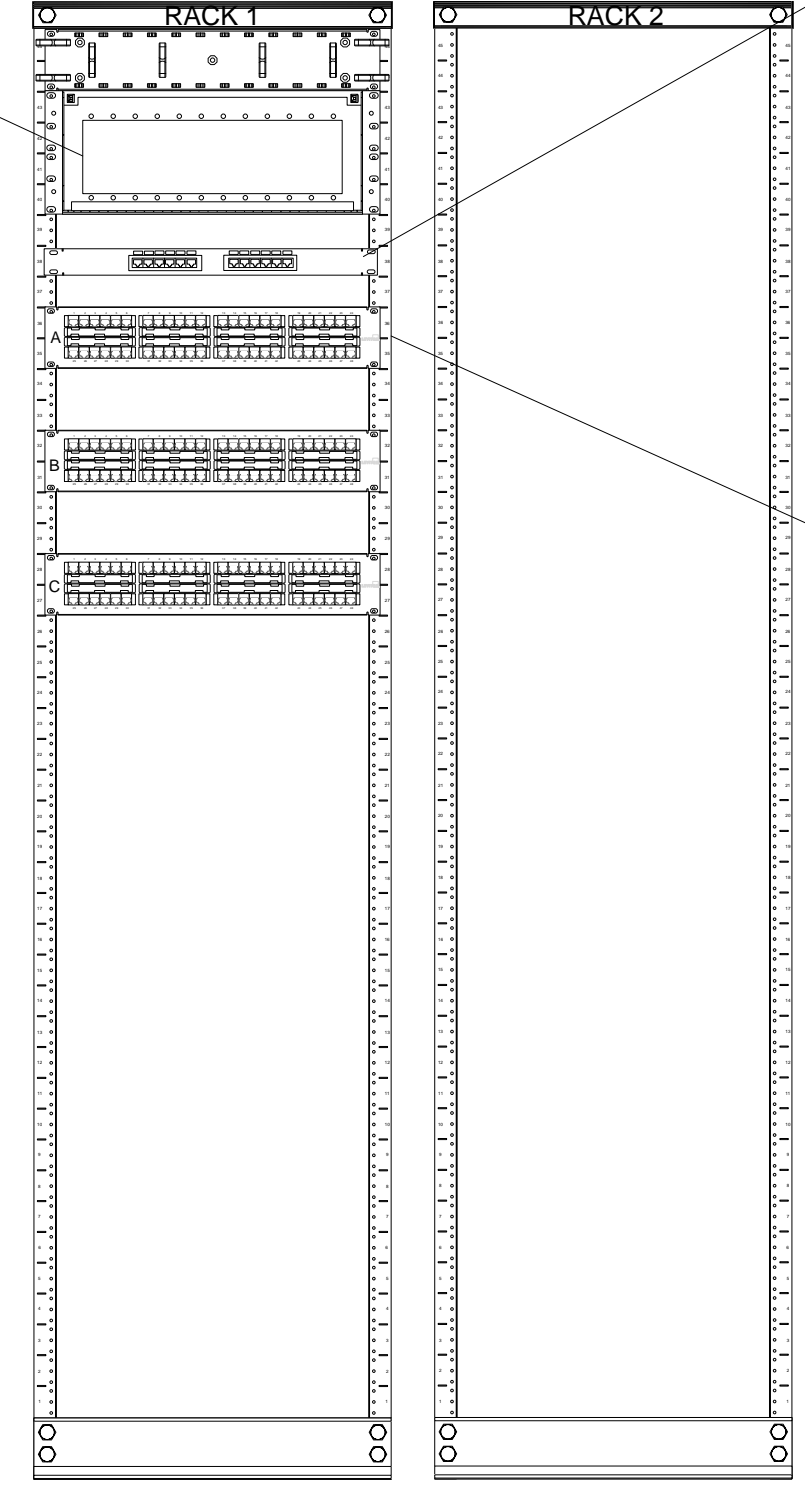

ENLARGED CATEGORY 6 PATCH PANEL DIAGRAM

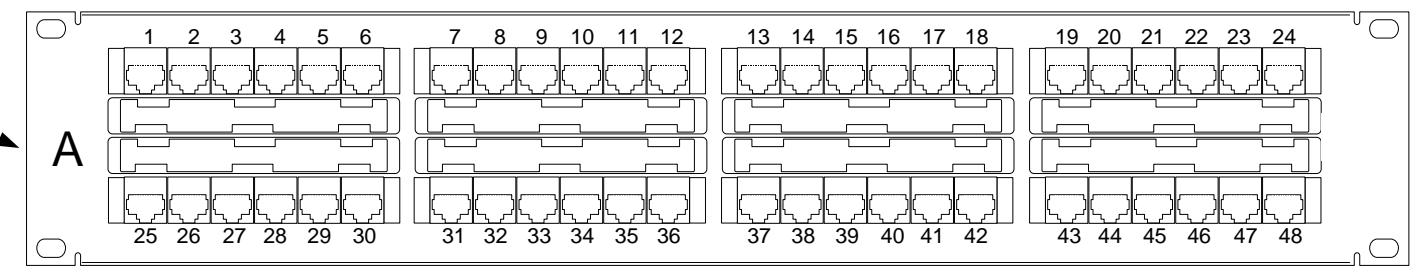

SYMBOL	REVISIONS DESCRIPTION	DATE	APPR.

DESIGNED BY: JOHN BABB	DATE: JUNE 2016	FOR OFFICIAL USE ONLY
DESIGNED BY: DEREK MITCHELL		
REVIEWED BY: ROBERT BABB		
USARMC G-6 RCDD		

USARMC G-6
NETWORKING AND
INFRASTRUCTURE
BRANCH
INFRASTRUCTURE
TEAM

U.S. ARMY RESERVE
NETWORK ENTERPRISE CENTER
INFRASTRUCTURE
TECHNICAL CRITERIA
DIAGRAM AND DETAILS

TYPICAL LABELING DIAGRAMS

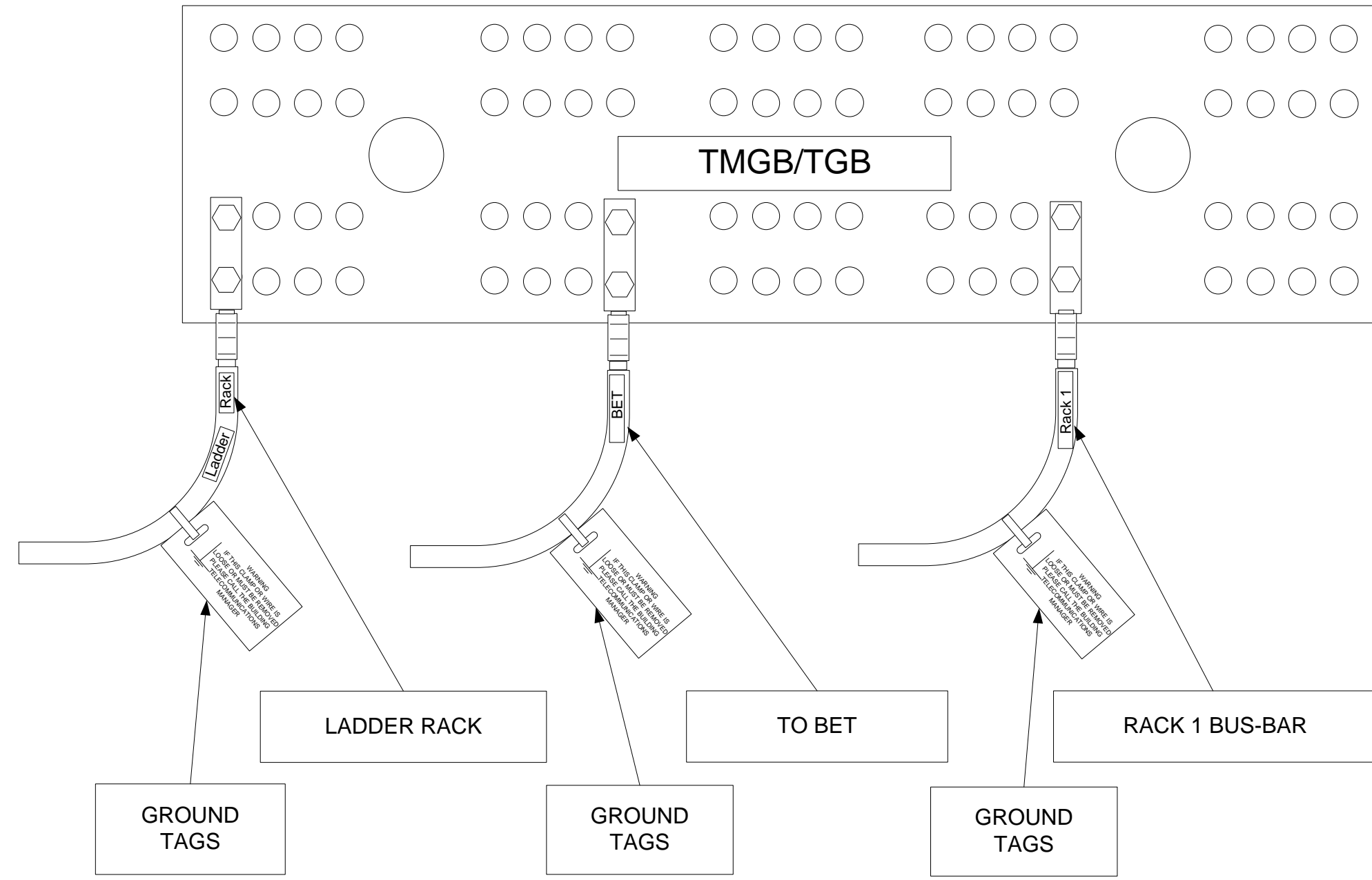

1 WALL MOUNTED BUS-BAR/GROUNDING CONDUCTOR LABELING SCHEME

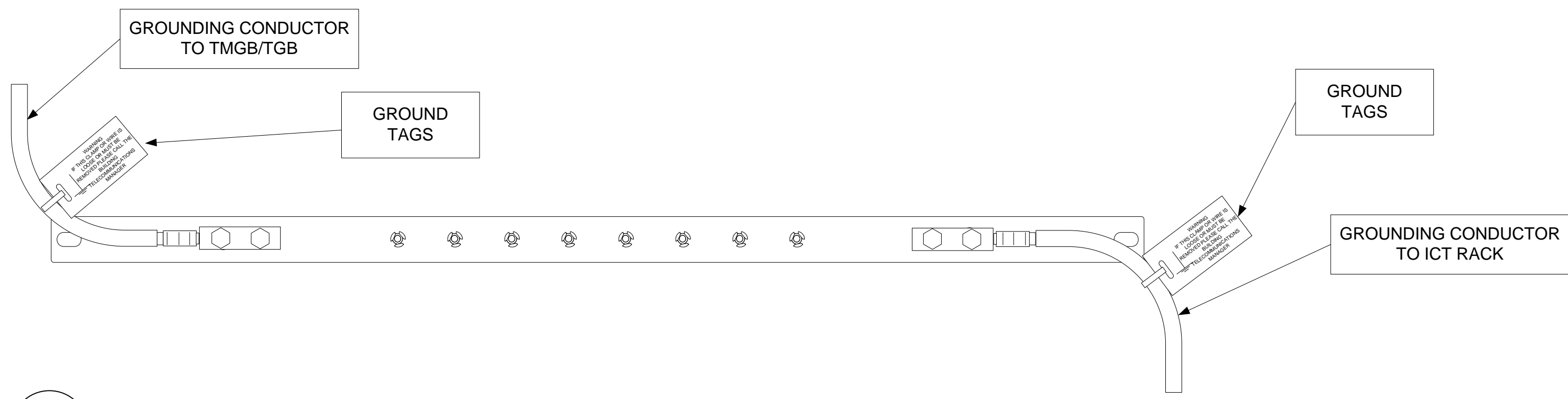

2 RACK MOUNTED BUS-BAR/GROUNDING CONDUCTOR LABELING SCHEME

TYPICAL GROUNDING BUS-BAR AND BONDING CONDUCTOR LABELS



SYMBOL	REVISIONS DESCRIPTION	DATE	APPR.

DESIGNED BY: JOHN BABB	DATE: JUNE 2016	FOR OFFICIAL USE ONLY
DESIGNED BY: DEREK MITCHELL		
REVIEWED BY: ROBERT BABB		
USARC G-6 RCDD		

USARC G-6
NETWORKING AND
INFRASTRUCTURE
BRANCH
INFRASTRUCTURE
TEAM

U.S. ARMY RESERVE
NETWORK ENTERPRISE CENTER
INFRASTRUCTURE
TECHNICAL CRITERIA
DIAGRAM AND DETAILS

B.46

SHEET KEY NOTES

- 1 WATER-PROOF SELF LAMINATING CABLE TAGS SHALL BE INSTALLED ON ALL BACKBONE CABLING WITHIN 1 FOOT OF ENTERING/ EXITING CONDUIT OR SPLICE CASES.
- 2 MAINTENANCE HOLE STENCIL

SHEET GENERAL NOTES

1. ALL DIAGRAMS ARE TYPICAL EXAMPLES OF THE LABELING SCHEMES ONLY AND ARE NOT REFLECTIONS OF PROPER CABLE TERMINATIONS, LOCATIONS OR REQUIRED MAINTENANCE HOLE COMPONENTS OR SIZE



SYMBOL	REVISIONS DESCRIPTION	DATE	APPR.

DESIGNED BY: JOHN BABB	DATE: JUNE 2016	FOR OFFICIAL USE ONLY
DESIGNED BY: DEREK MITCHELL		
REVIEWED BY: ROBERT BABB		
USARC G-6		USARC G-6 RCDD

**USARC G-6
NETWORKING AND
INFRASTRUCTURE
BRANCH
INFRASTRUCTURE
TEAM**

**U.S. ARMY RESERVE
NETWORK ENTERPRISE CENTER
INFRASTRUCTURE
TECHNICAL CRITERIA
DIAGRAM AND DETAILS**

B.47

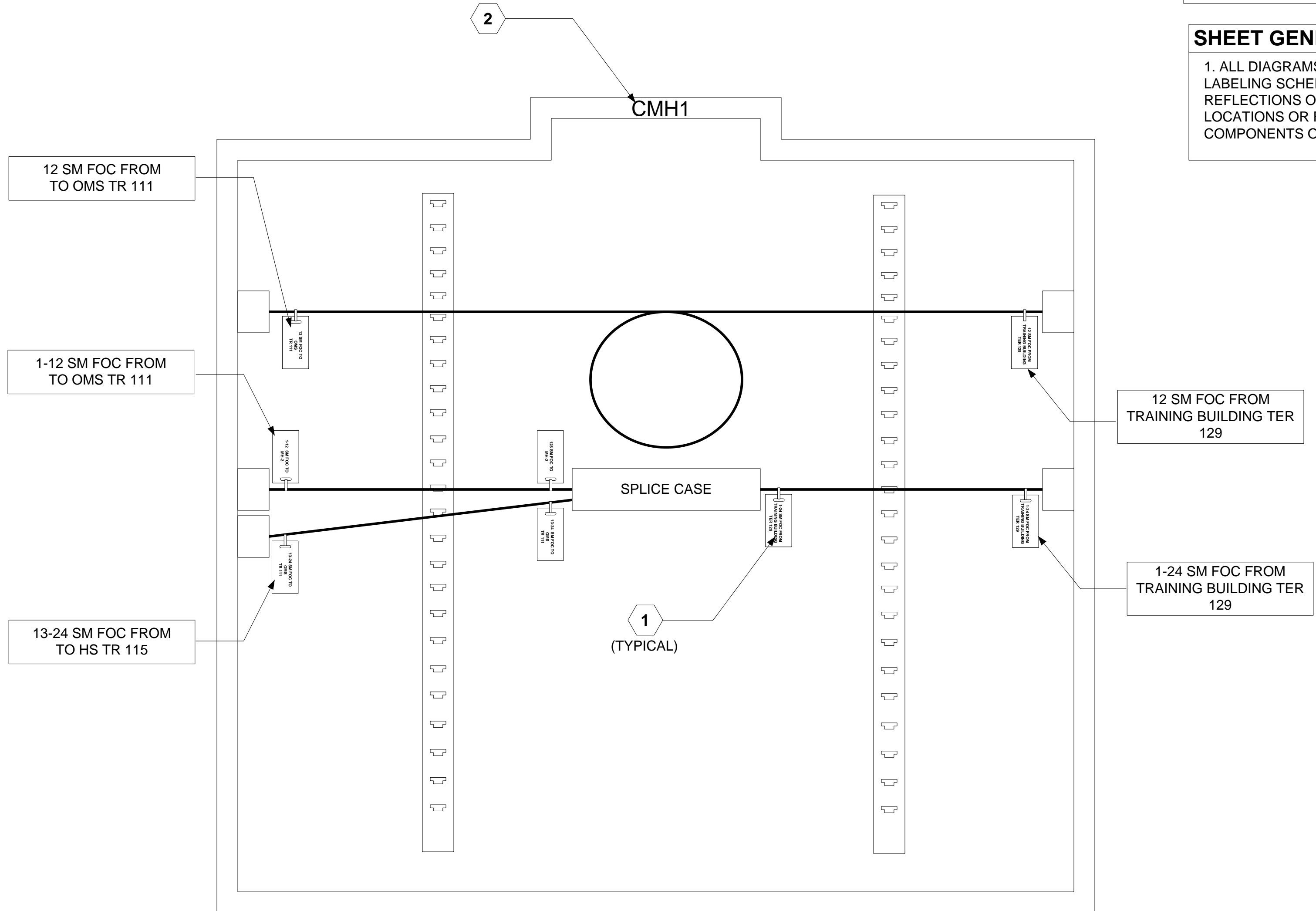

TYPICAL MAINTENANCE HOLE LABELING

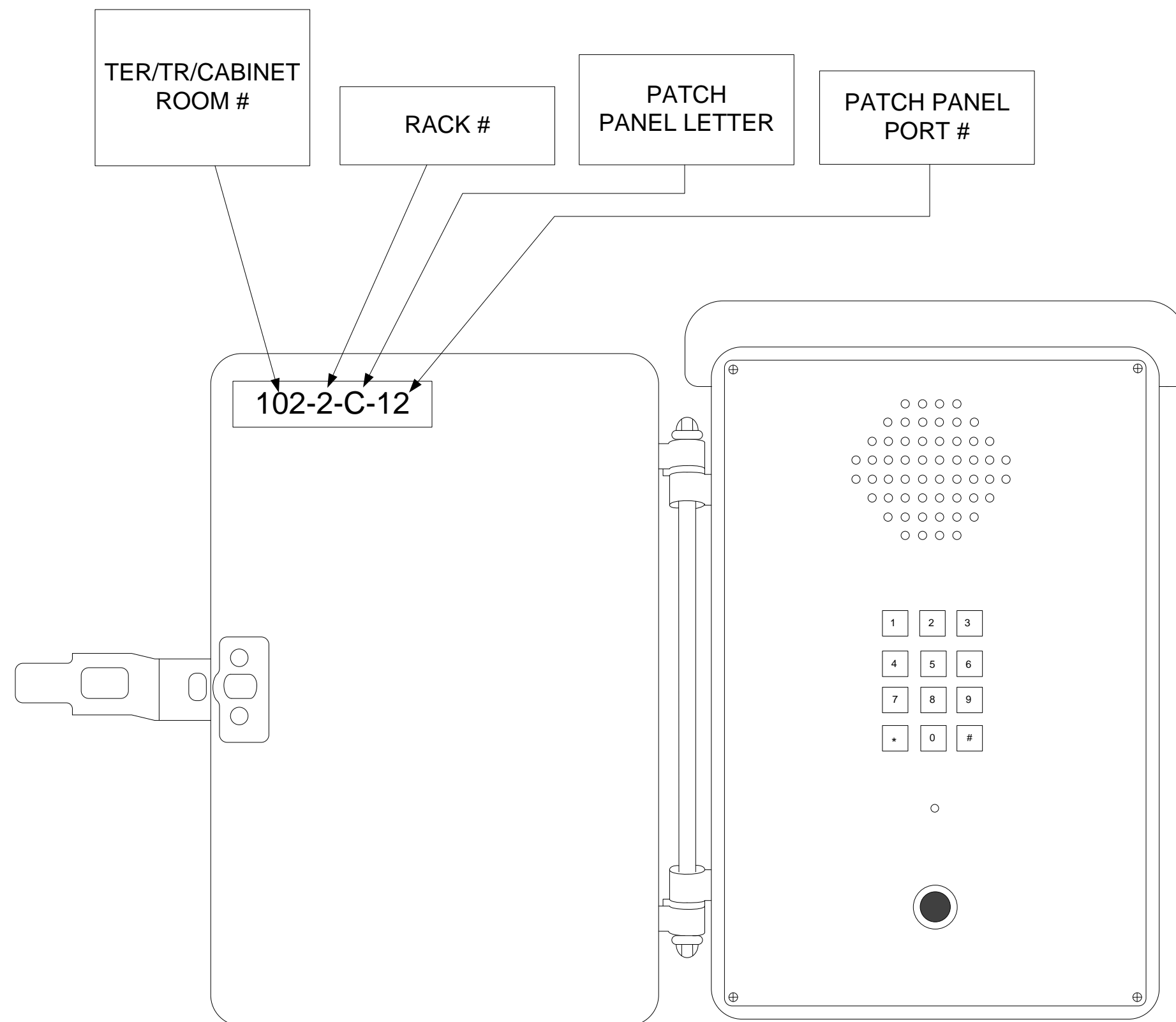

1 CALL BOX LABELING SCHEME

TYPICAL LABELING SCHEMES



SYMBOL	REVISIONS DESCRIPTION	DATE	APPR.

DESIGNED BY: JOHN BABB	DATE: JUNE 2016
DESIGNED BY: DEREK MITCHELL	FOR OFFICIAL USE ONLY
REVIEWED BY: ROBERT BABB	
USARC G-6 RCDD	

USARC G-6
NETWORKING AND
INFRASTRUCTURE
BRANCH
INFRASTRUCTURE
TEAM

U.S. ARMY RESERVE
NETWORK ENTERPRISE CENTER
INFRASTRUCTURE
TECHNICAL CRITERIA
DIAGRAM AND DETAILS

B.48